

Digital Banking 2.0

September 2021



India's Best Digital Bank



National E-Summit & Awards

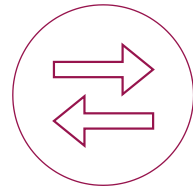

15%

Market share in UPI transactions¹

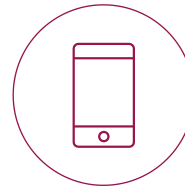

14%

Market share in Mobile transactions¹



















4.6

App ratings (Apple store)

1. In terms of volumes for Q1FY22

Digital Banking – Axis Bank’s “silent revolution”

 <p>D2C products</p>	<p>84% </p> <p>Digitally active customers(Q1FY22)</p>	<p>~74% </p> <p>Credit cards issued (Q1FY22)</p>	<p>67% </p> <p>New SA acquisition¹</p>	<p>69% </p> <p>Fixed deposits opened⁴</p>	<p>60% </p> <p>PL disbursed⁴</p>	<p>57% </p> <p>New MF SIP sales (Q1FY22)</p>	<p>4.6 </p> <p>Mobile App ratings</p>
 <p>Transformation</p>	<p>250+ </p> <p>Services on digital channels</p>	<p>15% </p> <p>Market share in UPI (Q1FY22)²</p>	<p>14% </p> <p>Market share in mobile (Q1FY22)²</p>	<p>90%</p> <p>Digital transactions³</p>	<p>65,000+ </p> <p>Staff on BYOD[~]</p>	<p>~975</p> <p>Automated processes (IA)</p>	<p>300+</p> <p>Employee tool Journeys</p>
 <p>Capabilities</p>	<p>~850</p> <p>People dedicated to digital agenda</p>	<p>~150 </p> <p>In-house development team</p>	<p>~75% </p> <p>New hires from non-banking backgrounds</p>	<p>PB</p> <p>Scale big data Hadoop clusters</p>	<p>120%</p> <p>Lift of bank credit model GINI scores over bureau</p>	<p>~50 </p> <p>Apps on Cloud</p>	<p>Agile</p> <p>Enabled teams with CI/CD, micro-services architecture</p>



<p>140 Mn</p> <p>KTB⁵ Customer base</p>	<p>4 Mn</p> <p>Non Axis Bank customers using Axis Mobile & Axis Pay apps</p>	<p>18%</p> <p>Contribution of KTB channels to overall sourcing of Cards (in Q1FY22)</p>
---	---	--

1. Digital tablet based account opening process for Q1FY22 2. by volume
 3. Based on all financial transactions by individual customers in Q1FY22 4. Digitally in Q1 FY22 5. Known to Bank

Digital leadership and technology driven transformation are key pillars of our GPS strategy

-  **Strengthen the organizational core and quality of our balance sheet significantly**
-  **Invest in technology capabilities to deliver on our Transformation plans**
-  **Act with relentless focus on making Axis digital**
-  **Build granularity across all our business segments to drive sustainable growth**
-  **Deliver strong operating performance with improvement in return metrics**
-  **Create significant value among our key subsidiaries**

Our digital strategy is aligned with our GPS strategy

A

Reimagine Customer Proposition



Digital-first products embedding design thinking



End-to-end simplification of customer journeys



Banking services **integrated across partner ecosystems**



Omnichannel experience to differentiate customer experience and **hyper personalization**

**B**

Transform the Core



Ops excellence & institutionalization of data & tech enabled operating rhythm



Twin-engine approach to build digital stack and **modernize the core**



Modular, resilient technology with **Cloud first** architecture



Proprietary in-house capabilities for accelerated design and go-to-market



Next gen **cyber security capabilities**

C

Build Future-ready Capabilities



Data architecture 3.0; moving beyond analytical models to **data engineering**



Integrating **alternate, unconventional data** for **risk-moderated growth**



Digital workforce for digital consumers



Creating a **cutting edge, future ready workspace 2.0**

OPEN: The operating system that drives every digital initiative in Axis Bank



O

0-based redesign; customer centric, design led and 0-operations

P

Proprietary **in-house capabilities**

E

Ecosystems capable; built for all Axis and partner channels

N





Numbers, Numbers, Numbers: Impact led and **metrics driven**

The OPEN philosophy underpins everything we do

- O** **0-based redesign**; customer centric, design led and 0-operations  **Playbook for agile, customer centric design** for all teams to collaboratively **change the Bank**
- P** Proprietary **in-house capabilities**  **Building in-house capabilities** on different elements such as design, experience centre, agile and AI centres-of-excellence among others
- E** **Ecosystems capable**; built for all Axis and partner channels  **Dedicated Partnerships team** and **market beating API strategy** to deliver the open ecosystems proposition
- N** **Numbers, Numbers, Numbers:** Impact led and **metrics driven**  **Organization-wide thrust** on **identification and tracking of outcomes** as well as input metrics to **drive Impact**

- Initiatives across **all customer segments** (retail, commercial, and corporate) and **employees**
- **Impact** targeted across different stages of the **customer lifecycle** (acquisition, cross-sell and up-sell, lifecycle management and risk management)

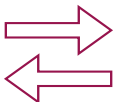
We are working on 30+ initiatives to execute our digital strategy

	Acquisition	Cross sell / Up sell	Lifecycle management	Risk management
Retail liabilities 	LEAP: Digital journey for CASA opening Partnerships for SA acquisition NTB acquisition for FDs	Pre-approved and e2e digital journeys for Bank and third party products: MFs, Digital Gold, Forex, PFM, credit cards, PL	Archetype based personalized automated journeys for priority segment	Managing Ops risk: Early alignment with ctrl functions, fast track processes; and Tech risk: Controlled and automated testing : Alternate data for customized credit and fraud models Digital Collections initiatives: Recalibrated for the Test and learn post COVID normal Credit process automation to reduce TAT
Retail assets 	Maximus: OD FD, Auto loans, Personal loans Buy now Pay later, Home loan Acquisition partnerships: GPay, Airtel, Freecharge and many more expected	Outward remittance on mobile app Buy now, Pay Later	Lifecycle management of all products on mobile app	
Payments & Cards 	Partnerships with Flipkart, Vistara Maximus: Axis led acquisition End to End Digital Issuance of Cards	Olive: Convert to EMI, CLI, card upgrade, instant loan	Olive: Convert to EMI, CLI, card upgrade, instant loan Card partnerships: Flipkart Card console	
CBG 	Digital CA acquisition Digital Business Loan Lending on informational collateral: GST, POS Sankalp: Technology led sales effectiveness	Sankalp: Technology led sales effectiveness and credit process transformation	Branch of the Future Mobile and Internet Banking	
Corporate 	Project Neo: Journey re-imagination, nudges on the platform for product recommendations, enhanced API proposition and partnerships with Neobanks, aggregators etc. and SCF platform revamp GCG initiatives: e-NAM, e-freight, e-tendering & e-auction, GeM procurement			
Internal employees 	Siddhi: Analytics based tool for sales and managerial effectiveness to enable meaningful customer conversations Digitally assisted journeys for sourcing via tab: Acquisition, cross-sell and upsell (on-KYC), enabled by BYOD Sankalp: Reimagined loan origination and credit process simplification along with tools data and digital for sales force effectiveness	Branch of the Future Saksham: branch portal for servicing Digitally assisted journeys for employees across onboarding, Covid Support, and day-to-day transactions	Digitally assisted journeys to support collections: App that enables geo-tagging, route planning, prioritized lists	
Each of these journeys is further transformed based on the OPEN philosophy				

Our digital strategy is aligned with our GPS strategy

A

Reimagine Customer Proposition



Digital-first products embedding design thinking



End-to-end simplification of customer journeys



Banking services **integrated across partner ecosystems**



Omnichannel experience to differentiate customer experience & **hyper personalization** 

B

Transform the Core



Ops excellence & institutionalization of data & tech enabled operating rhythm



Twin-engine approach to build digital stack and **modernize the core**



Modular, resilient technology with **cloud first** architecture



Proprietary in-house capabilities for accelerated design and go-to-market



Next gen cyber security capabilities

C

Build Future-ready Capabilities



Data architecture 3.0; moving beyond analytical models to **data engineering**



Integrating **alternate, unconventional data** for **risk-moderated growth**











Digital workforce for digital consumers





Creating a **cutting edge, future ready workspace 2.0**

Digital is an important customer acquisition engine for the Bank, which continues to achieve scale

	Product	Where we were (Dec '20)	Latest update (Jun' 21)	
Deposits 	Video KYC enabled Savings Accounts (non salaried)*	10%	~20%	
	Video KYC enabled Savings Accounts (salaried)	--	9%	
	Fixed Deposits (for existing and new customers)	71% ¹	69% ²	
Assets 	Personal Loans	54% ¹	60% ²	
	Credit card	78% ¹	74% ²	
	Credit Card – EMI conversion	29%	72%	

Digital is an important customer acquisition engine for the Bank, which continues to achieve scale

	Product	Where we were* (Dec '20)	Latest update* (Jun '21)	
Investments 	Mutual Funds (new SIP sales)	36% ¹	57% ²	
	Public Provident Fund	80%	95%	

¹ 9MFY21

² Q1FY22

* digital contribution to overall volumes

Our digital strategy is aligned with our GPS strategy

A

Reimagine Customer Proposition



Digital-first products embedding design thinking



End-to-end simplification of customer journeys



Banking services **integrated across partner ecosystems**



Omnichannel experience to differentiate customer experience & **hyper personalization** 

B

Transform the Core



Ops excellence & institutionalization of data & tech enabled operating rhythm



Twin-engine approach to build digital stack and **modernize the core**



Modular, resilient technology with **cloud first architecture**



Proprietary in-house capabilities for accelerated design and go-to-market



Next gen **cyber security capabilities**

C

Build Future-ready Capabilities



Data architecture 3.0; moving beyond analytical models to **data engineering**



Integrating **alternate, unconventional data** for **risk-moderated growth**



Digital workforce for digital consumers

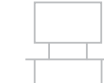













Creating a **cutting edge, future ready workspace 2.0**









We continue to introduce and scale new products driven by our *zero-based redesign philosophy*

Detailed further

Our product portfolio

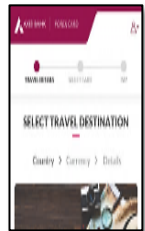
Deposits		Investments & Insurance		Loans & Cards	
					
Saving Accounts	Current Accounts	Mutual Funds	General Insurance	Personal loan	Credit cards
					
Fixed Deposit	PPF	Forex card	Life Insurance	GST based business loans	Auto loans

New launches

			
Buy Now Paylater	GrabDeals	Cards lifecycle	Auto loan
			
O/W Remittance	Digital Gold	Insurance 2.0	ODFD

0-operations based redesigned journey with customer at the centre, minimum to no data entry and all checks done by machines with automated underwriting

1: Buy Now Pay Later on Freecharge

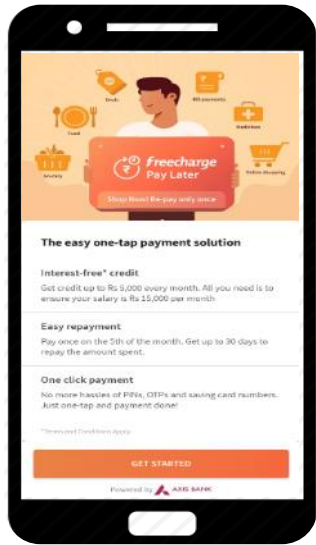

Customer clicks on paylater banner and can view details

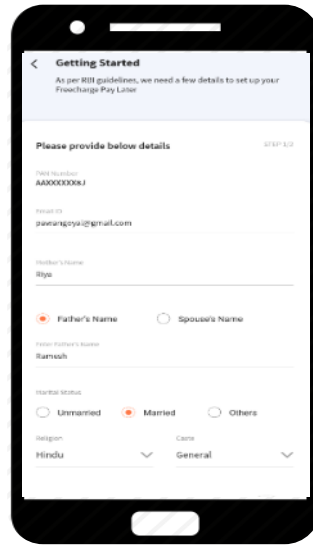

Customer provides basic personal details

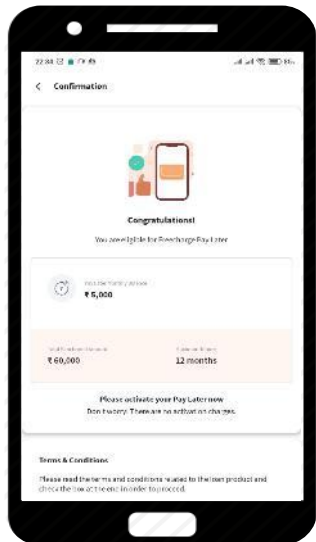

Customer is shown offer and Terms and conditions

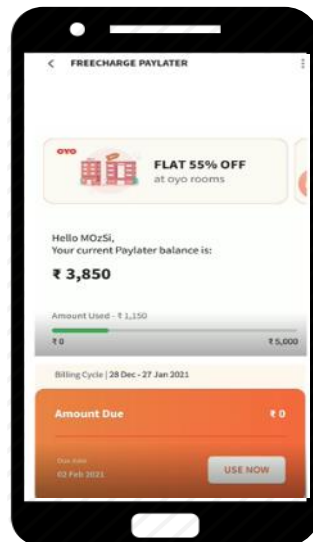

Customer can view remaining and utilised limit at anytime

O

Insta onboarding, decisioning & activation – all in **3 steps in less than 3 minutes**

Also available for new-to-Bank customers

P

Launched on the **Bank's proprietary Jarvis loan management platform**

E

Built in partnership with Freecharge – can be plugged in other platforms too

N

15x growth in customers and **20x** growth in transactions over last 3 months

1: Buy Now Pay Later on Freecharge | Developed on 'Jarvis': our in-house developed, cloud native, API oriented lending platform

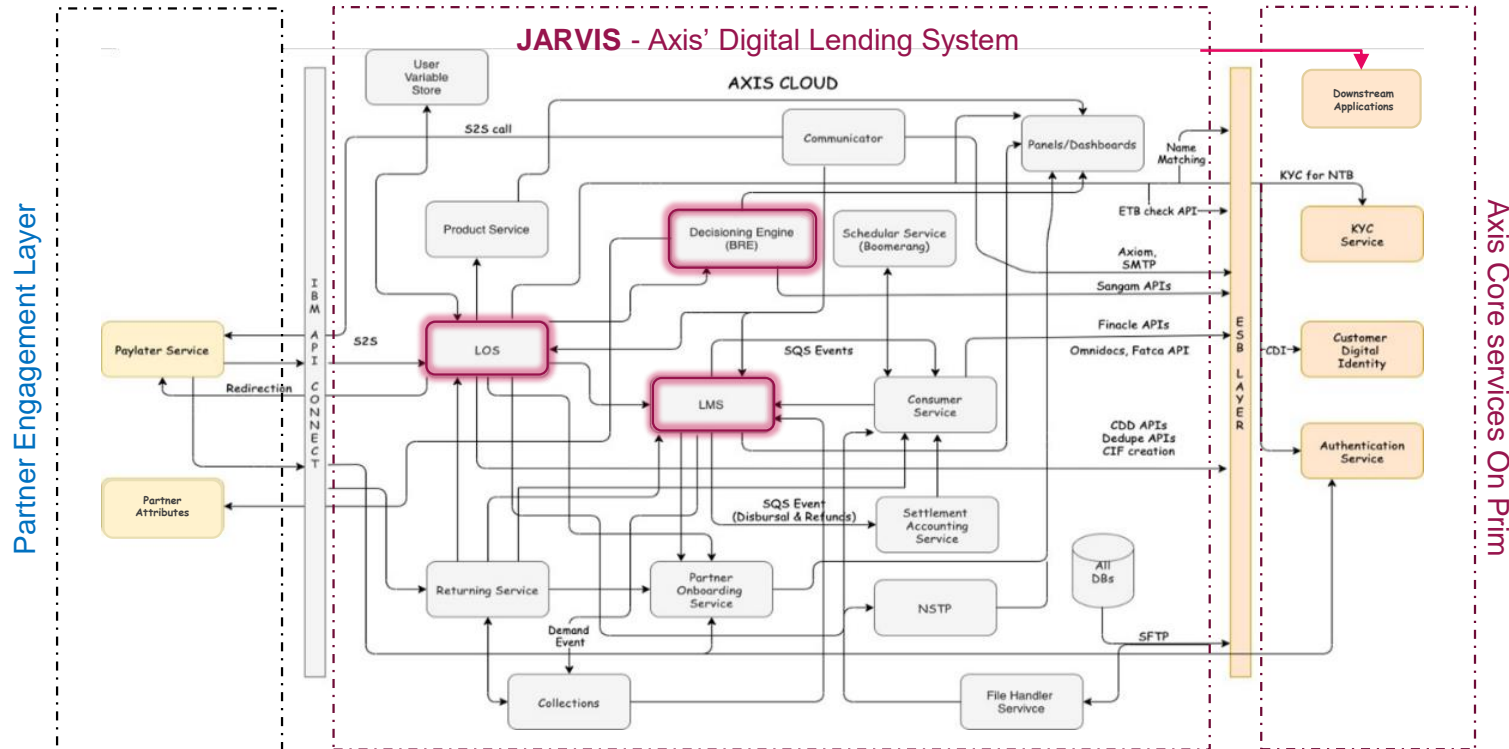

New-age Loan Management System

- Supports small ticket, small tenor, limit/loan, multiple interest rate/fee structures
- 100% digital journeys – No manual intervention

Custom built, Cloud native, API oriented

- Built, managed, run inhouse
- Built for partners
- Modular, loosely coupled
- 100% on AWS

Scalable and Customizable

- CI/CD in place with best practice AWS tools (externally recognized)
- Custom built BRE – Runs multiple policies
- All forms of KYC supported

Integrated with downstream systems

- Collection & recovery
- Statutory & regulatory reporting
- Financial reporting

2: Leap | Digital Savings Account onboarding

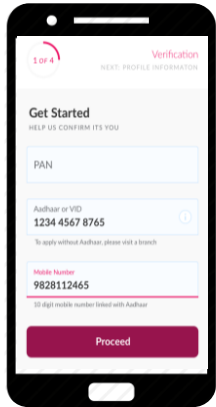

After choosing from 5 SA variants, Customer shares Aadhaar, PAN and mob number for EKYC

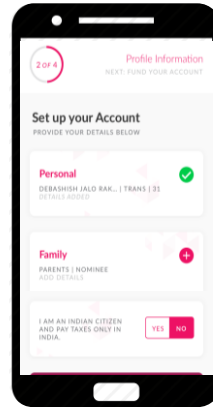

Customer provides personal, family and address details

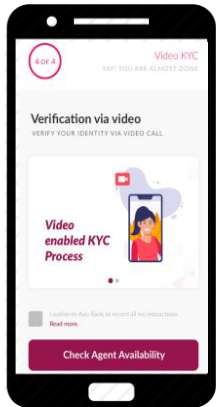

After successfully initiating VCIP, customer makes payment for Initial Funding

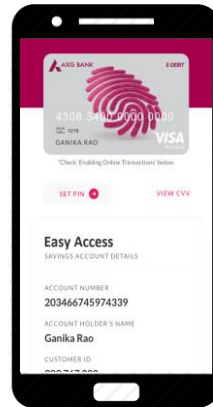

Account and Virtual Debit Card details are displayed and shared on email



O

Mobile first, customer driven design with **~90% of savings accounts** getting **activated within 24 hours**
Higher flexibility on schemes vs. peers

P

Axis Bank's **first application** to be **hosted completely on the Cloud**

E

Designed to scale with **micro-services** at each step that cater to all other VCIP applications as well

N

~20% of Retail SA (excluding salary) acquired digitally with **16%** better true rate

2: Leap Digital Savings Account | Impact

Operational impact, Indexed

Physical documents required

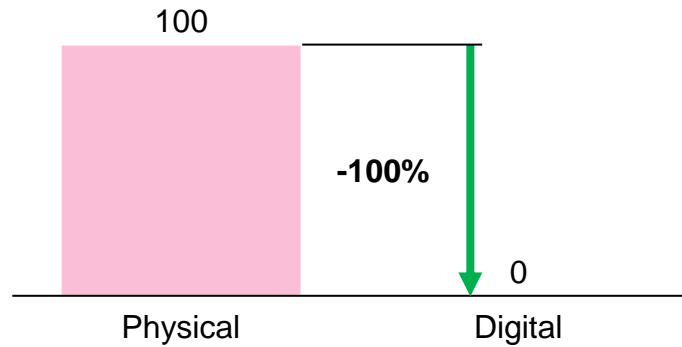

NTRF*

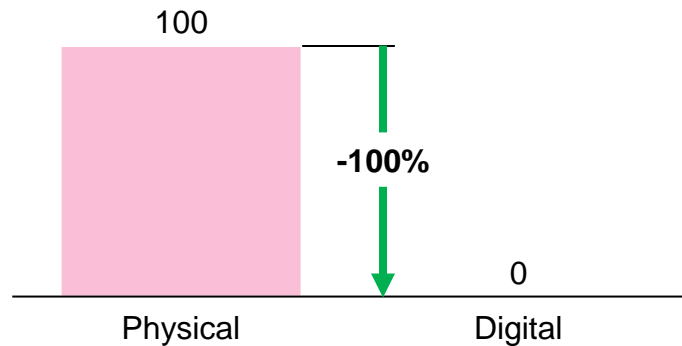

Financial impact, Indexed

Cost of acquisition

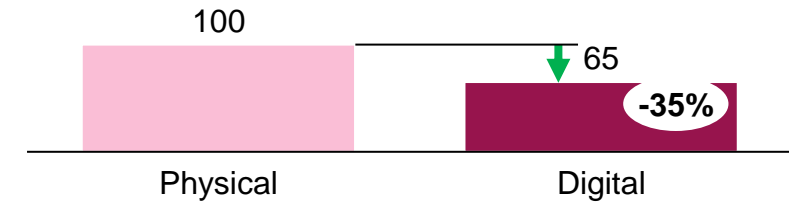

True rate

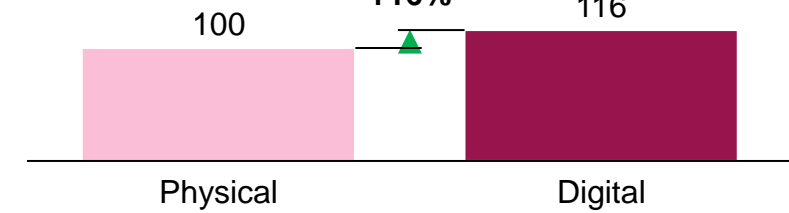

Digital activation

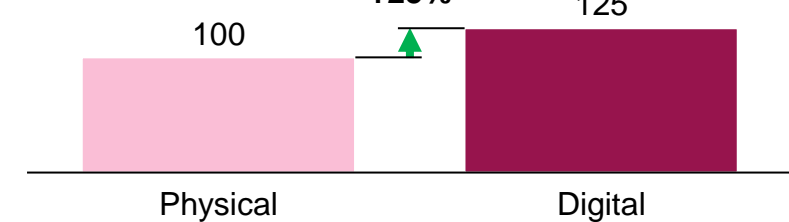

* NTRF – Not First Time Right

3: Outward Remittance journey on mobile

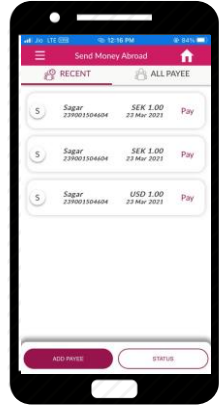

One view of recent payees for easy txn initiation

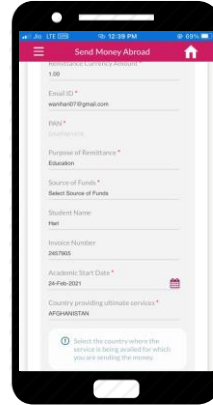

Capture all mandatory information

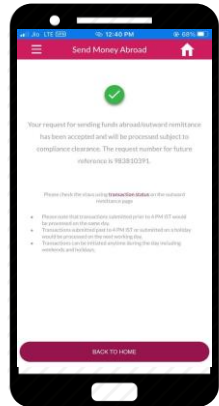

1 working day TAT for txn processing



O

One of the **first banks to launch outward remittance** through Mobile

P

Agile, proprietary hybrid solution for quick turnaround for **issue resolution**

Android web view leveraged for in-house development

E

Offered to partners through APIs for specific use cases such as Integration with brokers to allow overseas investments

N

New channel for outward remittance transactions leading to an increase in **throughput - 133% increase in 3 months** and **share of digital increased from 20% to 40%**

3: Outward remittance journey on mobile | Impact

Operational impact, Indexed

Transactions

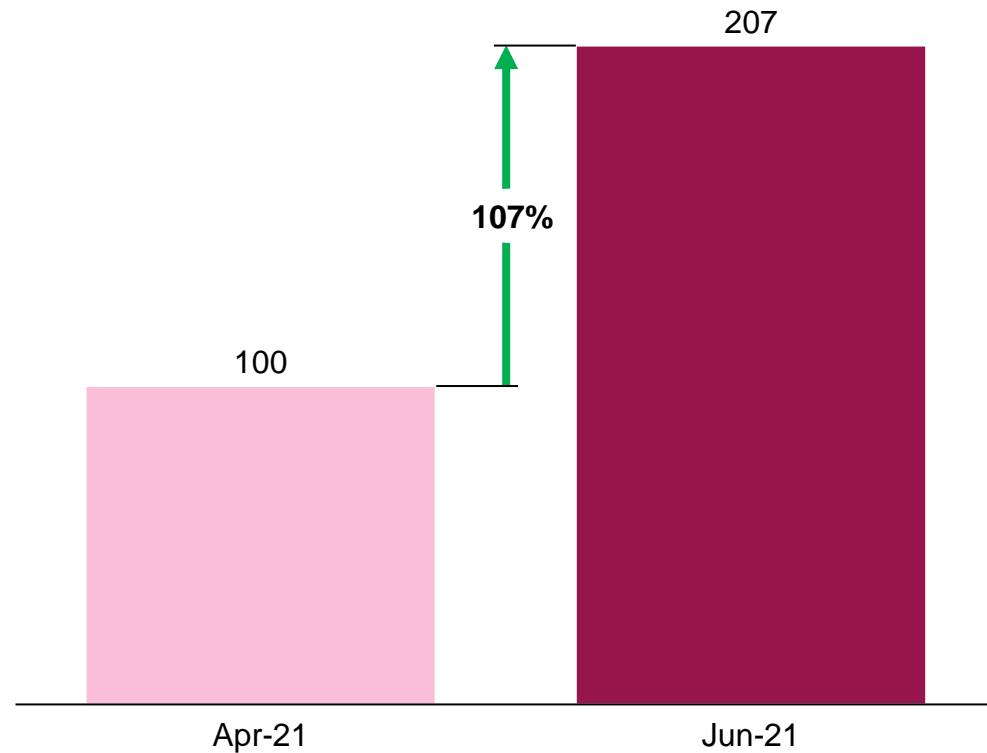

Financial impact, Indexed

Throughput

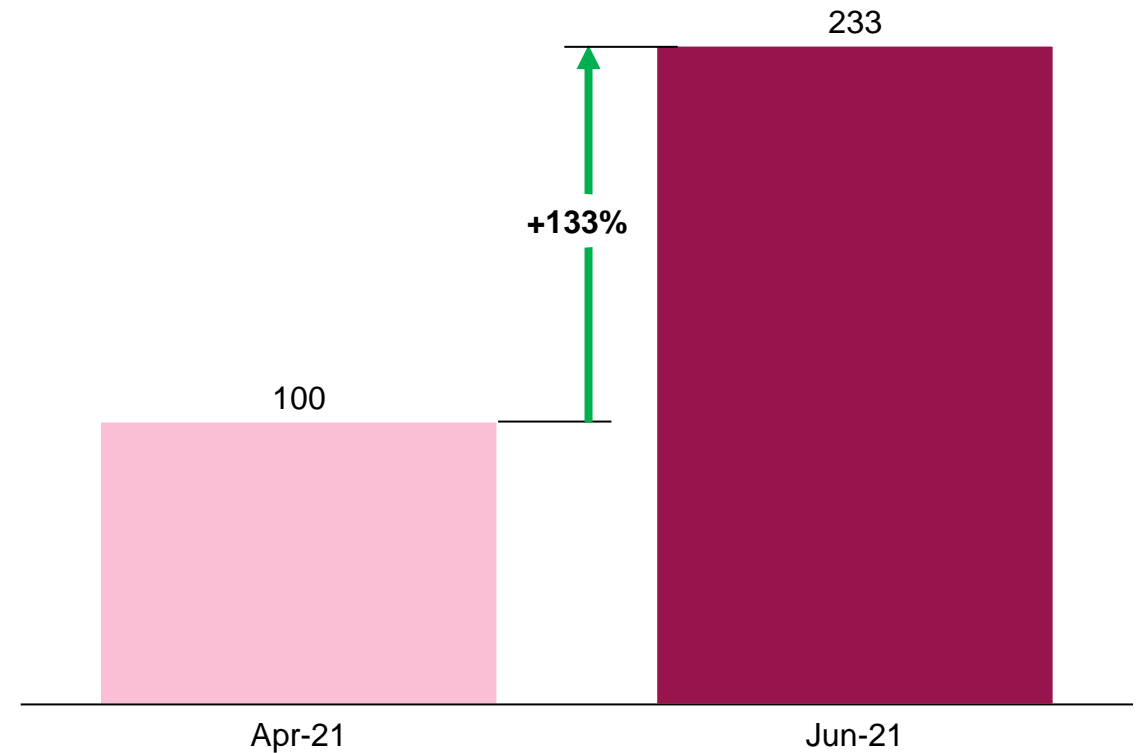

Share of digital increased from **20%** to **40%** during the period

4: Mutual Funds | Online Investment

Key steps in the journey

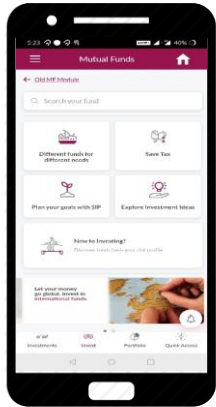

MF home page

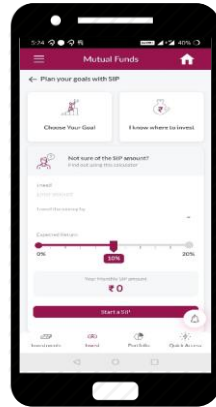

Plan your goals with SIP

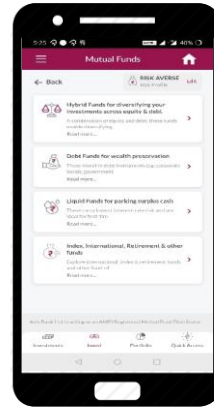

Invest basis Risk profile

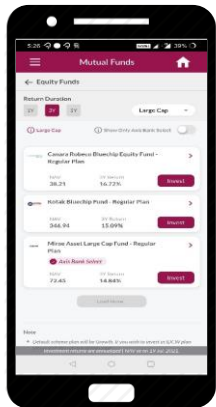

Scheme listing



Scheme details

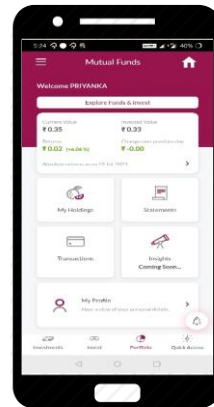

Portfolio view

O

Only Bank to have an **Online & Instant investing journey**, including for new-to-MF customers

0 paperwork

P

Online & Instant KRA KYC process leveraging customers' CKYC

E

Ecosystems capable across all Axis channels to facilitate easy and quick onboarding of AMC partners

N

Focus on increasing fresh SIPs & SIP book - **~100% YoY growth** in Q1FY22

4: Mutual Funds | Online Investment | Impact

Customer impact, Indexed

Fields to be entered

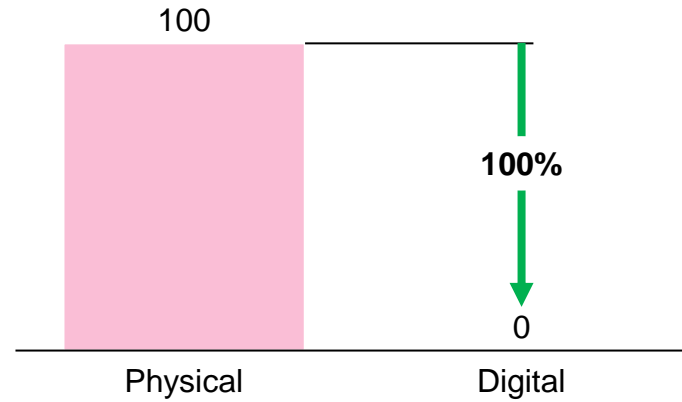

Operational impact, Indexed

Physical documents required

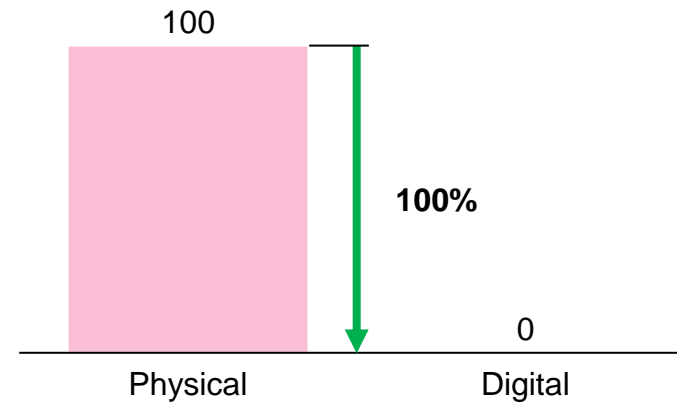

Digital Penetration

Digital Fresh SIP Volume

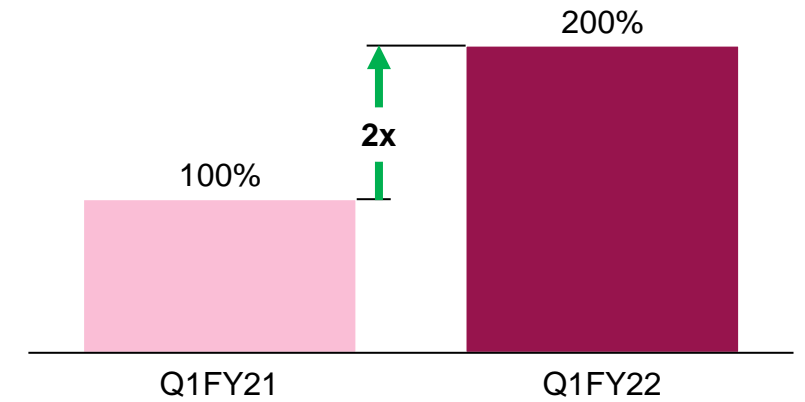

NSTP

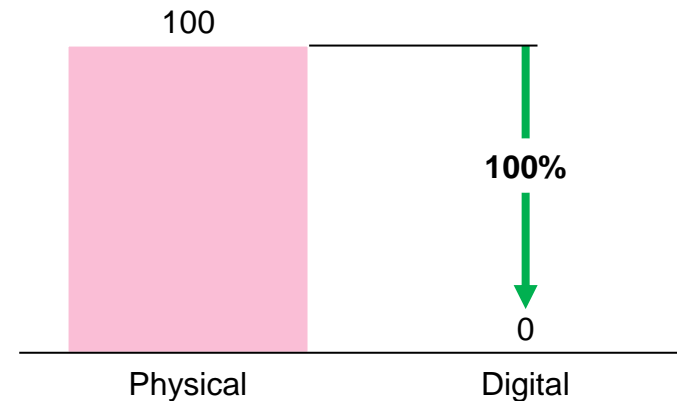

5: Grabdeals e-commerce marketplace | Grabdeals Fest to help achieve blitz scale and gain significant customer traction



About Grabdeals Fest

10 Days

15% Flat discount

2 Partners

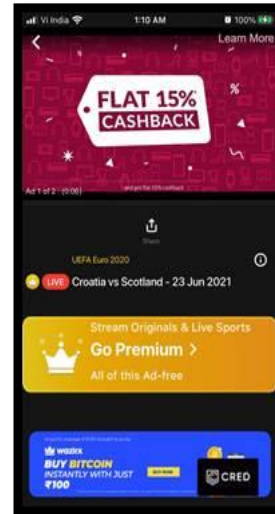

25 Mn impressions

8 Mn views on YouTube

O

Simple 3-step process to avail cash back on Grab Deals: *Browse* → *Authenticate* → *Shop*

Integrated with **WhatsApp channel**

P

Seamless CX due to close integration with **Axis mobile** and **internet banking**

Planned integration with **Axis's UPI platform**

E

Expandable, Dynamic Cloud based solution to enable **rapid partnerships**
40+ brands available on the platform

N

5x growth* in **Gross Merchandise Value** over last year exit numbers

* Monthly GMV in Jun'21 over Mar'21

5: Grabdeals e-commerce marketplace | Impact

Customer impact



Offers all year round; Benefits over and above the cards and merchant offers

Simple process to avail cash back

Over **40+ major brands** to choose from
(among the highest in industry)

Operational / Sales impact



Better Proposition to pitch products such as Savings accounts / Credit cards

Sales Aid / Pitching tool - **Conversation starter** for all cold calls

Financial impact



Indexed

GMV

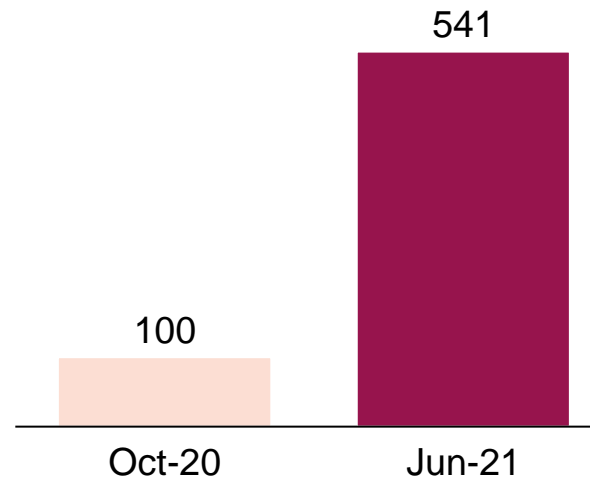

of transactions

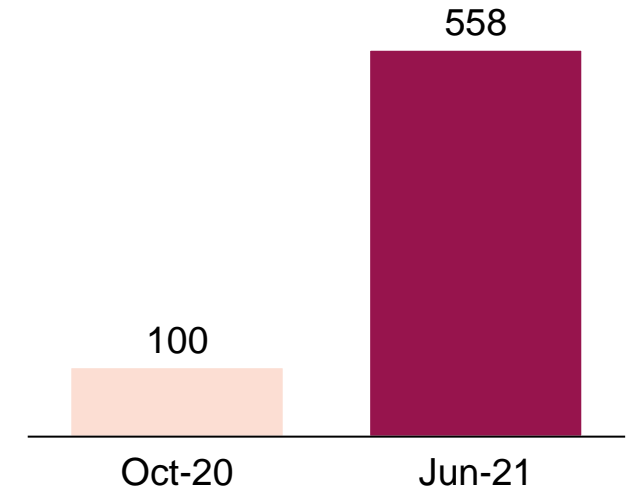

Customers who shop on Grab Deals maintain **100% higher balances** than Saving accounts holders who don't shop

Increased spends on Debit (140%) & Credit cards (30%) during Grab Deals Fest



Our digital strategy is aligned with our GPS strategy

A

Reimagine Customer Proposition



Digital-first products
embedding design thinking



End-to-end simplification of
customer journeys



Banking services **integrated**
across partner ecosystems



Omni-channel experience to
differentiate customer experience &
hyper personalization

B

Transform the Core



Ops excellence & institutionalization of
data & tech enabled operating rhythm



Twin-engine approach to build digital
stack and **modernize the core**



Modular, resilient technology with
cloud first architecture



Proprietary in-house capabilities for
accelerated design and go-to-market



Next gen **cyber security capabilities**

C

Build Future-ready Capabilities



Data architecture 3.0; moving beyond
analytical models to **data engineering**



Integrating **alternate, unconventional**
data for **risk-moderated growth**



Digital workforce for
digital consumers



Creating a **cutting edge, future**
ready workspace 2.0

1: Maximus | 24x7 Personal Loan

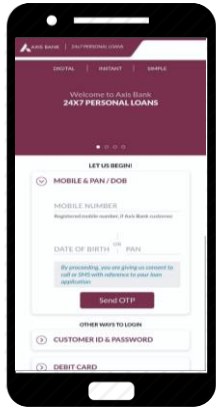

Customer can login using various login options

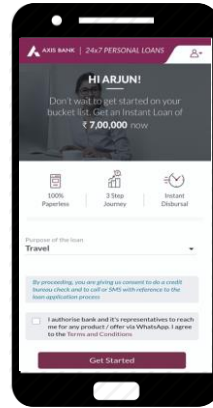

Customer confirms available information

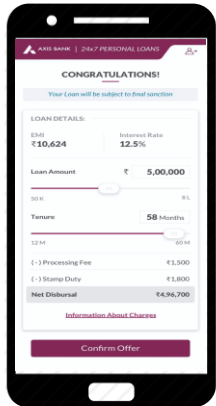

Customer is shown offer and Terms and conditions

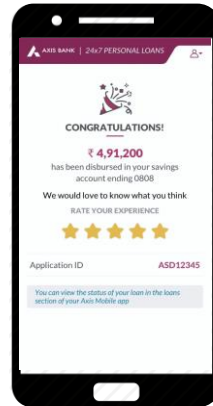

Signs Digitally and receives Digital Disbursement

O

Integrated four step customer journey

Multiple Login Options

Instant e-Sanction and e-Disbursal

Instant set-up of repayment from Axis Bank Account

P

Bank's proprietary underwriting model

Advance Curation of personalised offers

Use of advance analytics to arrive at eligible customer base

Online fraud assessment and detection

E

Ecosystems capable and available on all Axis Digital Properties

Built as micro-services; extendable to internal channels as well as external partners

N

Spearheading change - 60% of the disbursement was Digital in Q1FY22;

Significant reduction of e2e TAT from 7 days to 15 mins

1: Maximus | 24x7 Personal Loan | Impact

Customer impact, Indexed

End-end disbursement TAT

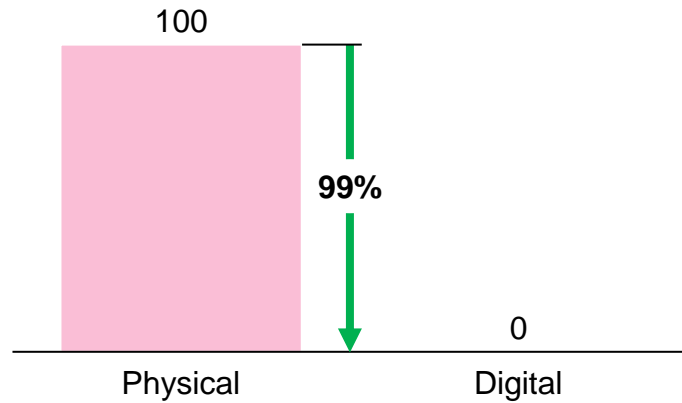

Operational impact, Indexed

Physical documents required

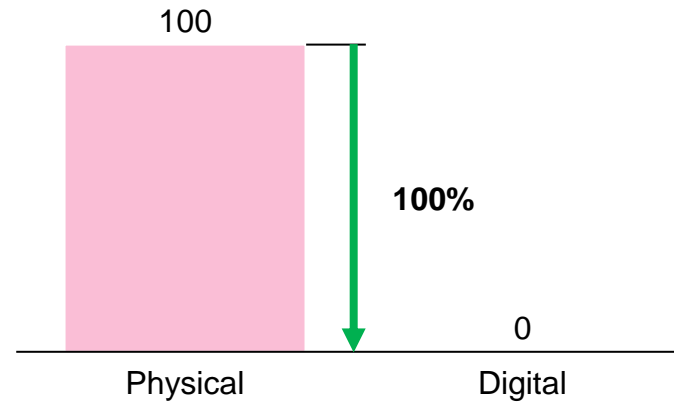

Financial impact, Indexed

Cost of acquisition

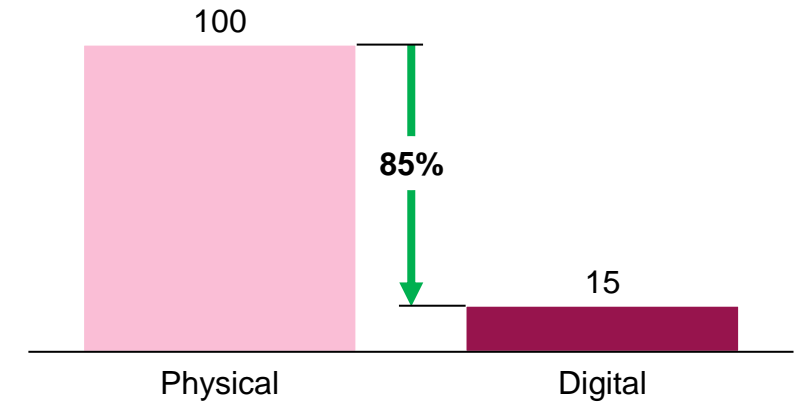

Fields to be entered

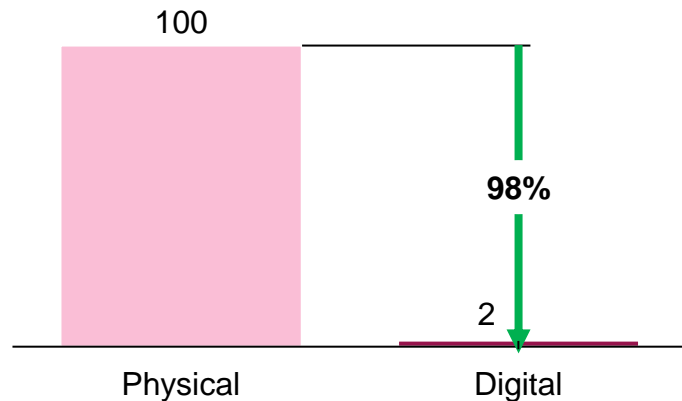

Non STP**

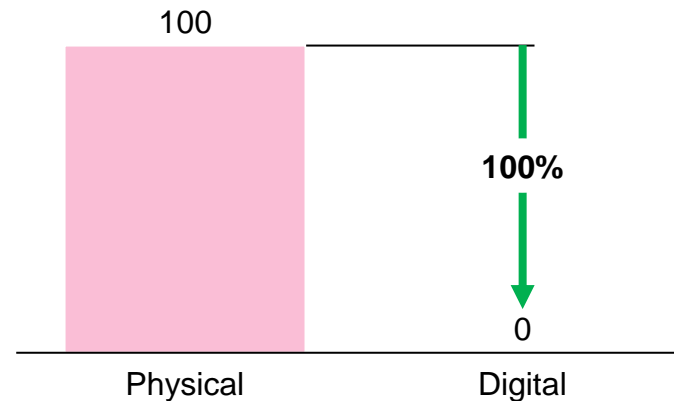

Contribution to overall PL sourcing (%)

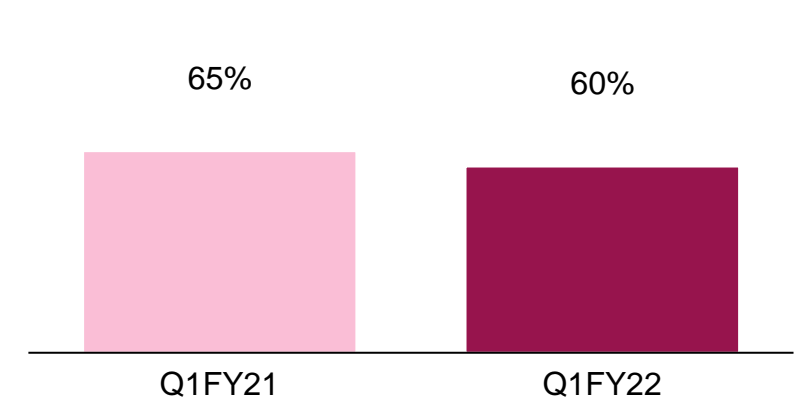

** STP – Straight through processing

2: Maximus | 24x7 Business Loan



Customer can login using various login options

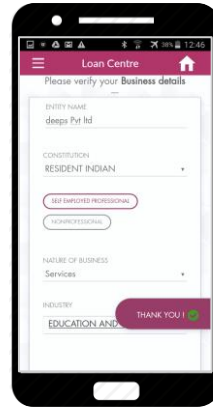

Customer confirms available information



Customer is shown offer and Terms and conditions

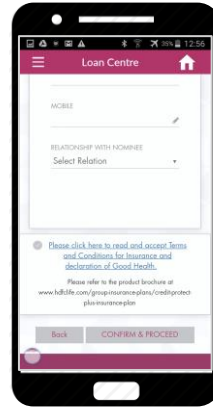

Signs Digitally and receives Digital Disbursement



O

Customer centric design with minimal data collection to deliver a seamless customer experience

Built for Self Employed customers

Instant e-Sanction and e-Disbursal

Instant set-up of repayment from Axis Bank Account

P

Bank's proprietary underwriting model

Advance curation of personalised offers

Use of advance analytics to arrive at eligible customer base

Online fraud assessment and detection

E

Ecosystems capable and built in for customer self-initiated as well as assisted journeys

Online identification and classification of PSL eligible customers

N

Spearheading change - 42% of the disbursement in Q1FY22 facilitated through digital

2: Maximus | 24x7 Business Loan | Impact

Customer impact, Indexed

End-end disbursement TAT

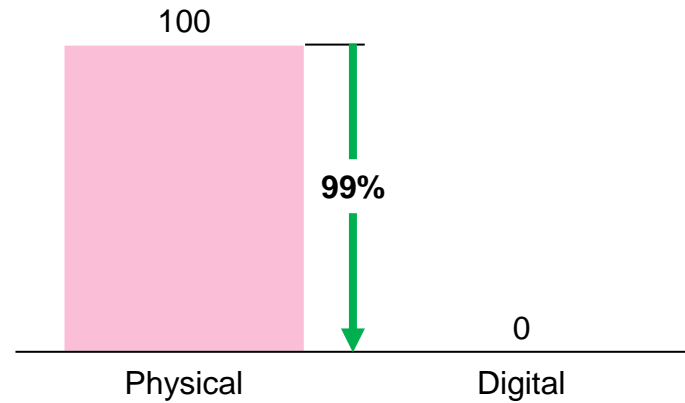

Operational impact, Indexed

Physical documents required

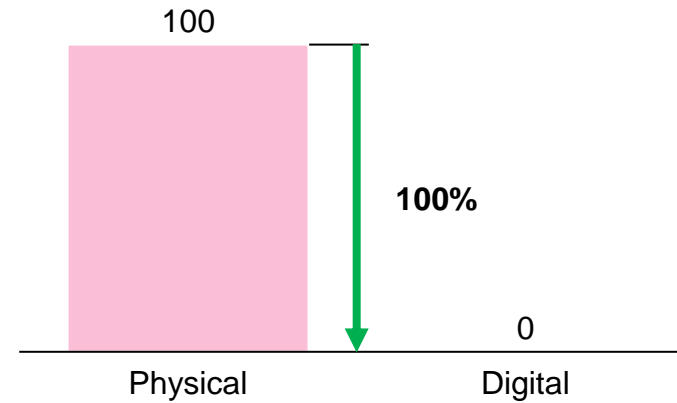

Financial impact, Indexed

Cost of acquisition*

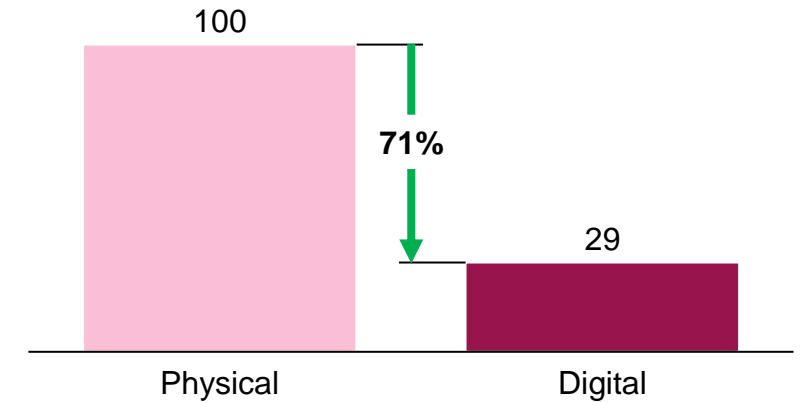

Fields to be entered

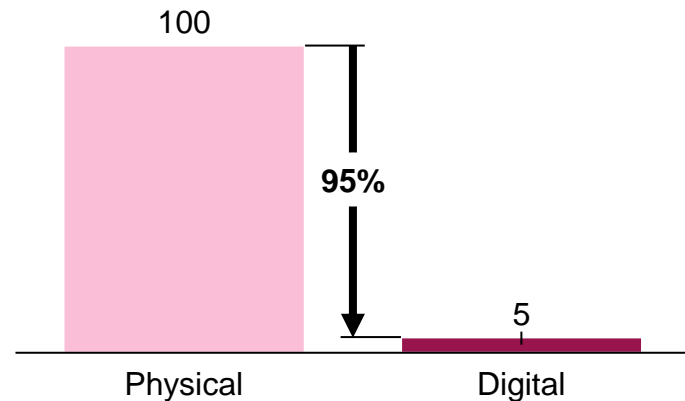

Non STP**

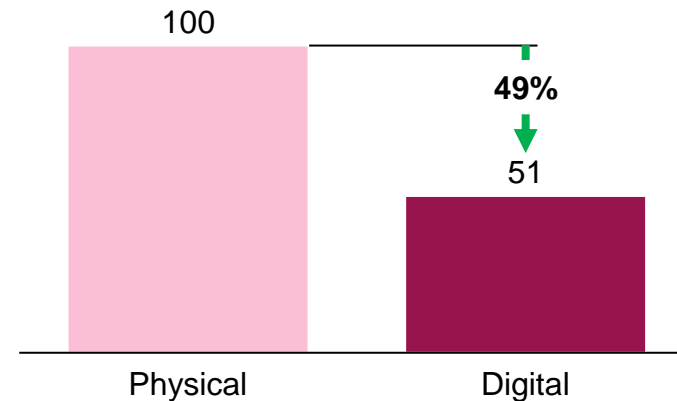

Contribution to overall BL sourcing (%)

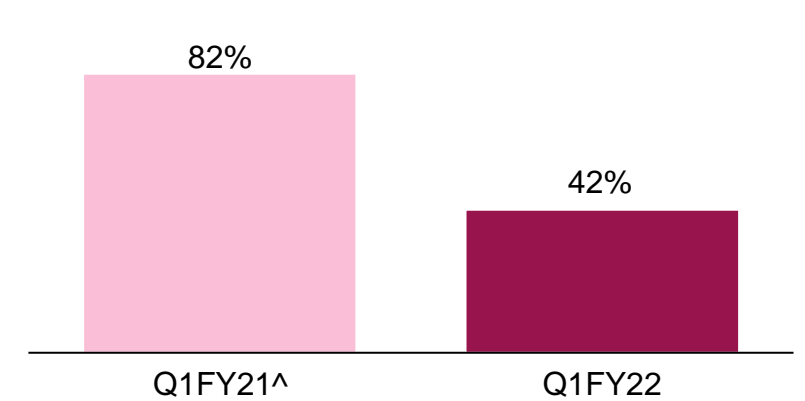

*Sales sourcing cost

** STP – Straight through processing

^ Physical business sourcing was severely impacted due to Covid

3: Maximus | 24x7 Auto Loans

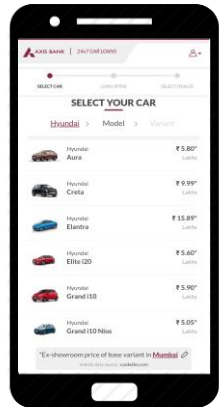

Customer selects car

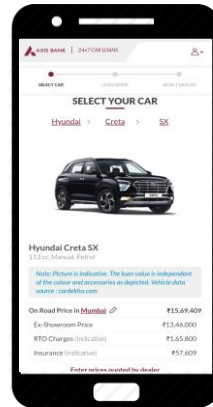

**Customer confirms/
provides asset cost**

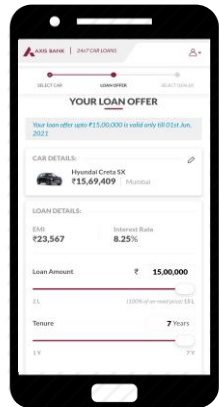

Customer customizes the loan offer

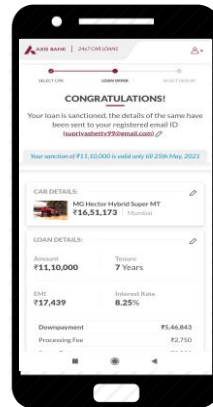

Customer receives instant sanction



O

3 steps in 3 minutes - Instant onboarding, car selection & decision making

Instant set-up of **repayment** from Axis Bank Account

P

Built on Bank's **exclusive Digital Lending platform** with best in class interactive customer facing journeys.

Proprietary Axis Bank underwriting model

Online fraud assessment and detection

Seamless integration with **credit decision engine**

E

Ecosystems capable and available on all Axis Digital Properties

Integration with Car Dekho to get updated model and pricing

Integrated with all internal channels as well as dealer at Point of sale;

Integrated with Partner OEMs - **MSIL, HML, PSA Citroen**

N

Spearheading change - **7% of disbursement** in Q1FY22 facilitated through the bank's Digital Lending platform

3: Maximus | 24x7 Auto Loans | Impact

Customer impact, Indexed

End-end disbursement TAT

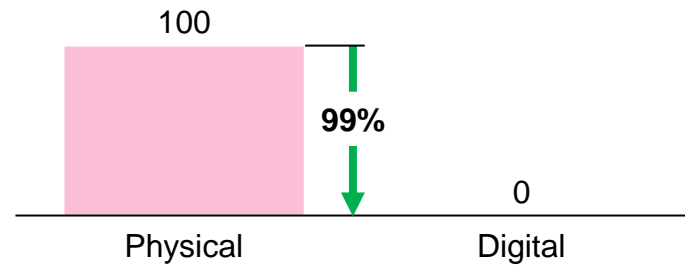

Field to be entered

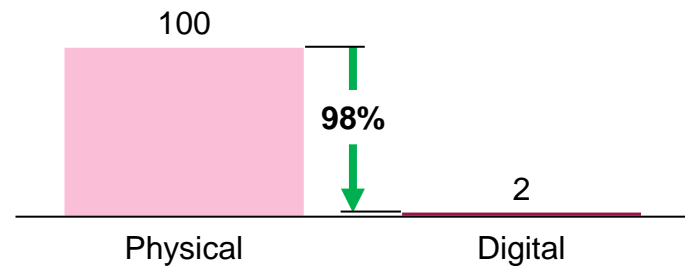

Manual/Back Office Tasks

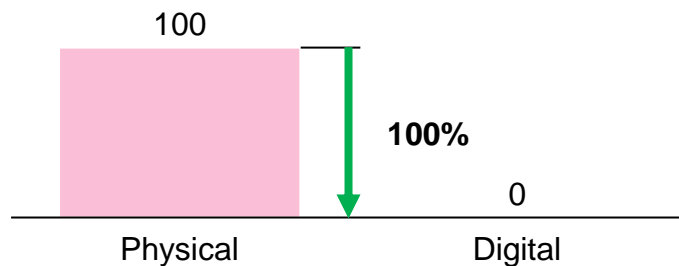

Operational impact, Indexed

Physical documents required

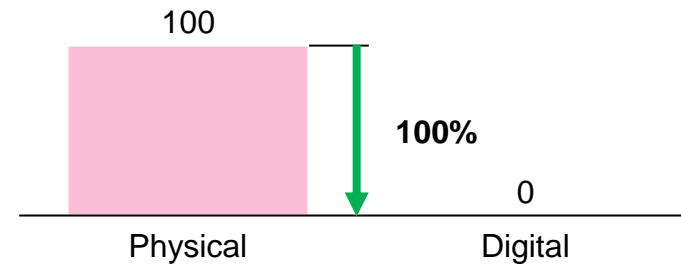

NFTR

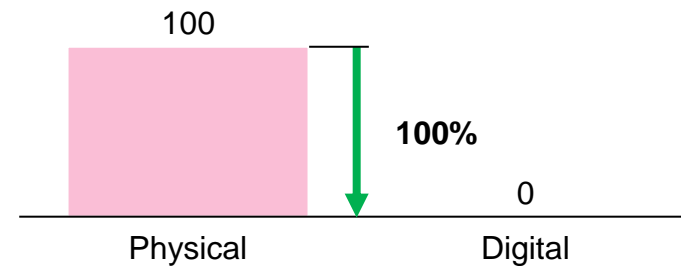

Digital Penetration

Contribution to overall sourcing (%)

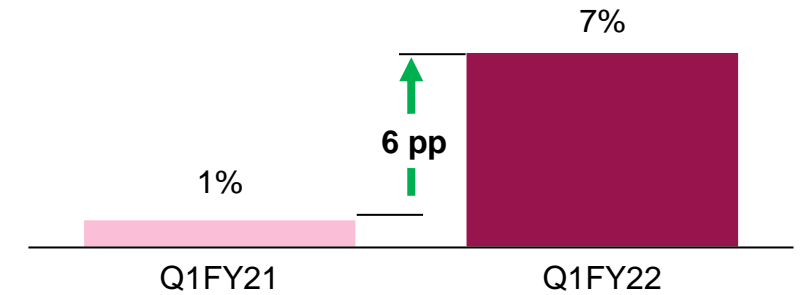

4: 24x7 ODFD | Fully digital, instant account opening

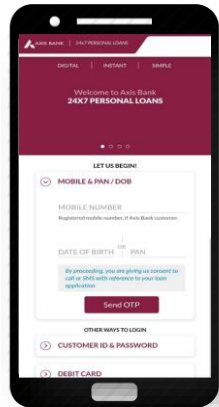

Customer can login using various login options

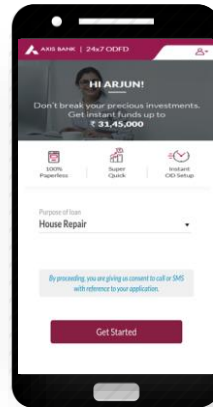

Customer confirms available information

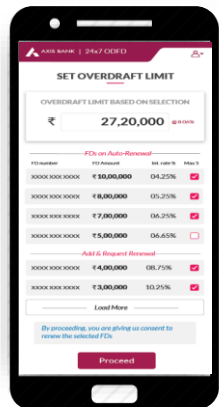

Customer selects desired FDs and OD limit

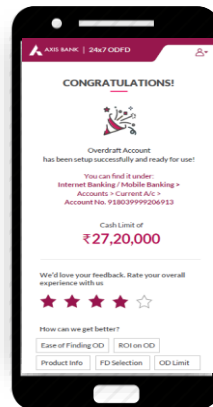

OD Account is opened instantly



O

All integrated **three step** customer journey
Instant limit set against customer FDs
Multiple FDs can be selected
Available across **NRI** and **Agri Customers**

P

Built on Bank's proprietary **Digital Lending Platform**
Templated underwriting significantly reduces time on journey

E

Available on all Axis digital properties
Fully secure
Facilitates **Customer retention**
Online **identification and classification** of PSL for eligible customers

N

Spearheading Change - 72% of the limit set-up was digital in Q1
Significant reduction in e2e **TAT** from **2 days to 5 mins**

4: 24x7 ODFD | Impact

Customer impact, Indexed

End-end disbursement TAT

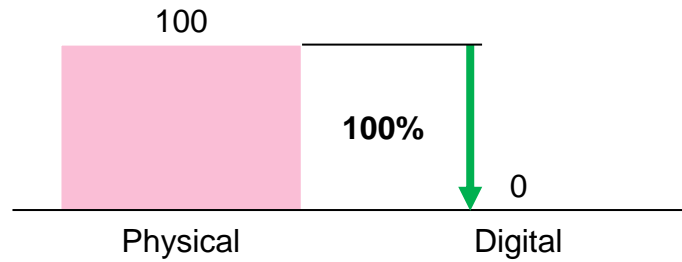

Fields to be entered

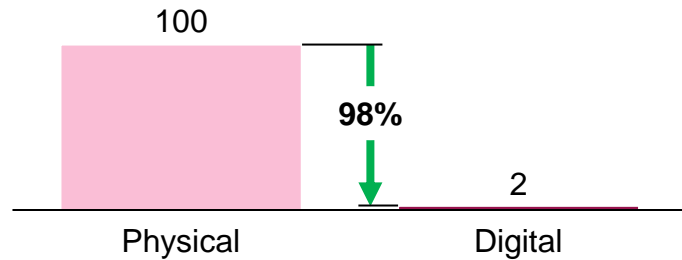

Operational impact, Indexed

Physical documents required

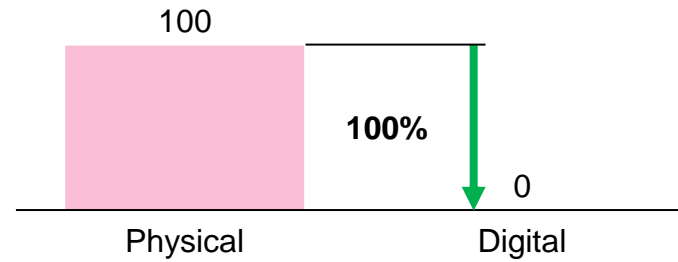

NFTR

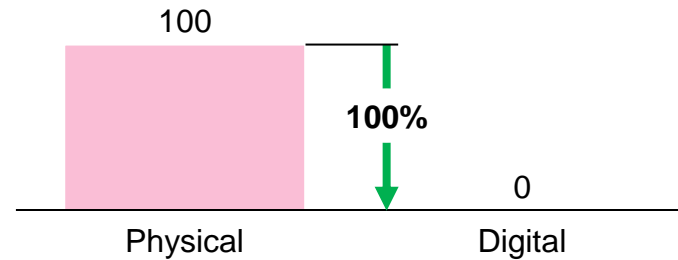

Manual/Back Office Tasks

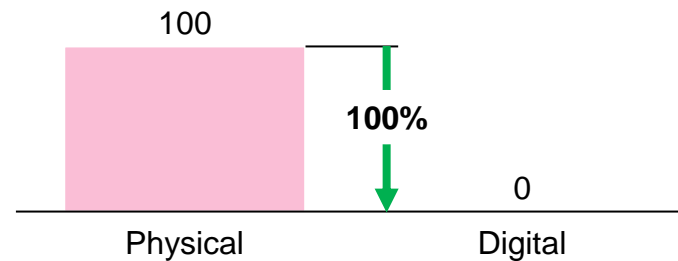

Financial impact, Indexed

Cost of acquisition*

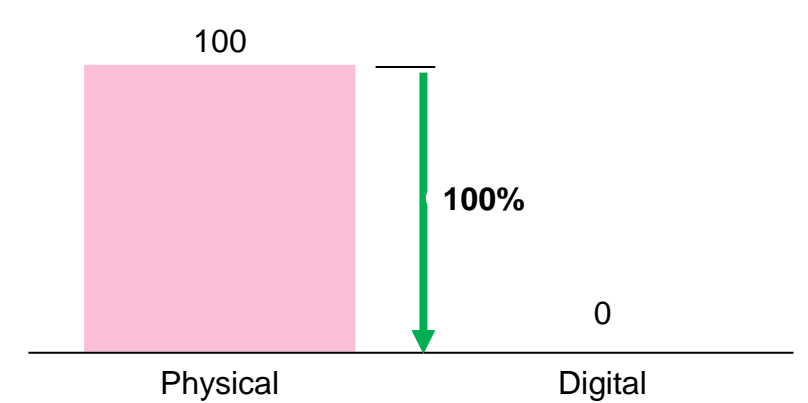

Contribution to overall ODFD sourcing (%)

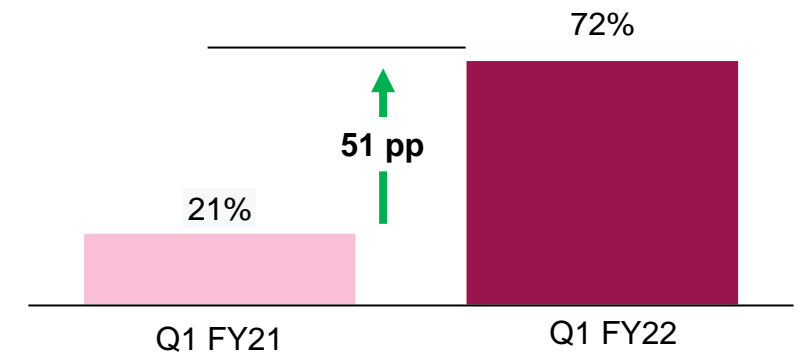

*Sales sourcing cost

5: Digital Home Loan | Instant digital sanction for Axis Bank approved projects

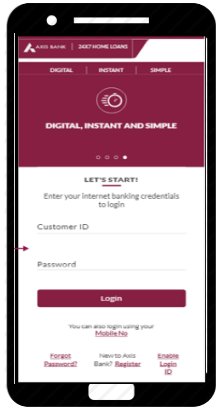

ETB customers can login using customer ID and password or mobile and PAN/DOB. NTB using their mobile and PAN/DOB

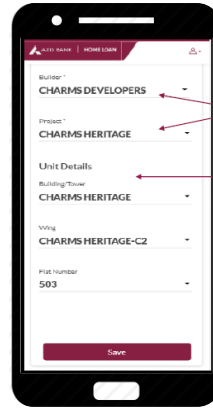

Application is specific to an Axis Bank approved project. Customers select the builder and project details

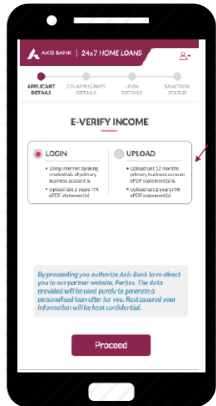

Income assessment is done using either Perfios or Netfetch (depending upon customer's choice)

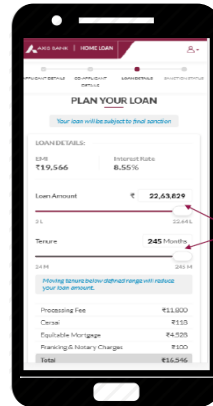

After applicant and one co-applicant complete their journey customer selects the loan amount and tenure



Customer receives an instant sanction on mail, can also be downloaded on the platform

O

Digital, Instant and paperless sanction. Customers can avail a sanction from the project site or comfort of their homes
Only Bank among peers to have a paperless journey for salaried customers; and only 1 document required for self-employed

P

Launched on the Bank's proprietary Lending platform
Proprietary Axis Bank underwriting model

E

Can be integrated with other platforms such as online property aggregators

N

Reducing the TAT from 3 -7 days to instant/same day sanction for STP cases
Number of projects, applications and disbursal value being tracked closely

6: Thanos | Insurance marketplace to aid distribution growth

Key steps in the journey

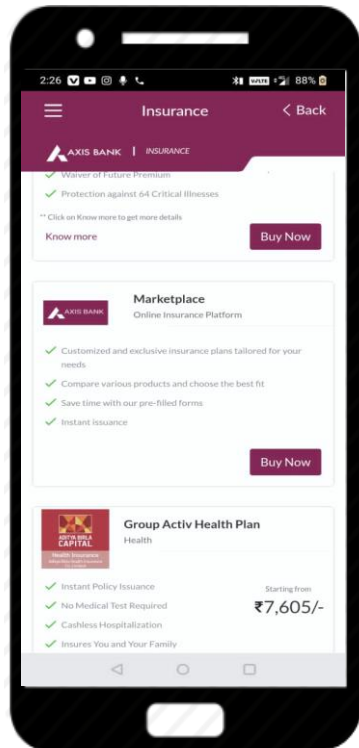

Customer lands on Investment Landing Page

General, Health & Life Insurance

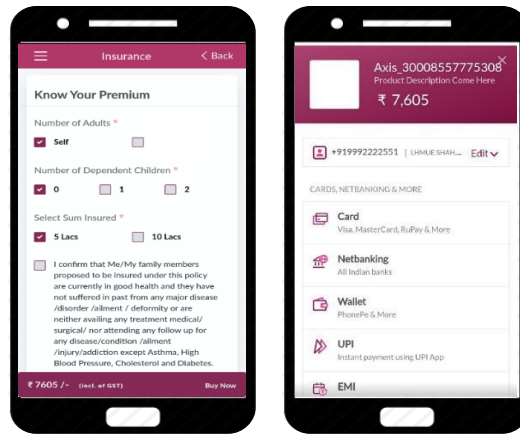

Redirection Journey: Customer fills personal details and makes payment via PG on Partner platform

Marketplace

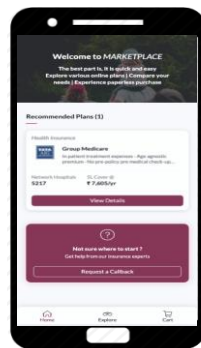

Customer fills personal details and makes payment via direct debit or PG on Axis Bank's platform

O

STP paperless journey with prefilled application & instant policy issuance capability

A single platform for customers to choose from **multiple Insurance Products** across Partners

P

Marketplace Model: Hosted on the Bank's server and APIs of partners are invoked to generate the Quote and Demog Services are invoked to pre fill customer details

Redirection Model: A single standardized payload API created to share customer details with multiple partners

E

Ecosystems capable across all Axis channels to facilitate easy and quick onboarding of insurance partners

N

Recently launched, regular tracking of numbers to ensure scale

7: Merchant Acquisition Business (MAB) | Focus on growth acceleration with state-of-the-art digitization

Aspirations to achieve leadership in POS

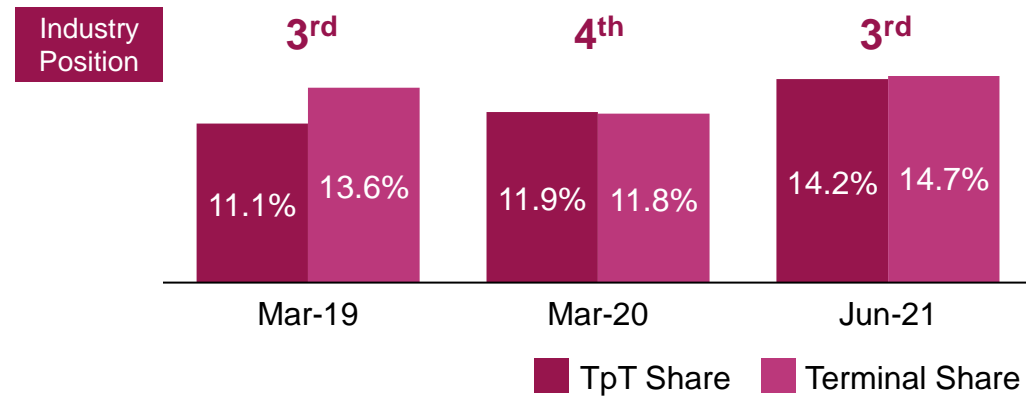

Key capabilities that fostered past growth



Android POS

State-of-the-art terminal with VAS of Khaata & BQR (40% sourcing)



Aggregator partnerships

Extension of digital payments ecosystem fintech aggregators



Merchant In a Box

Instant swipe machine—India's first proposition to enhance the onboarding experience, completed within 30 minutes

Further capabilities to become the “Bank of choice”



Taking Bank to Merchant

Co-origination & conversion drives (CASA balances at 18% YoY growth)
Lending: Focus on new product design to meet merchant's needs



Launch of Digital Tools

Merchant Onboarding App: Digital onboarding for STP
Merchant Engagement App: Relationship deepening & servicing tool
Salesforce Enablement App: Merchant management tool



Building Digital Capabilities

UniPG 2.0: Payment gateway wrapper with multiple payment options under one umbrella, to the merchant via a single platform integration
Neo Bank: Powerful features like integrated invoicing, GST compliance to address key pain points of target merchants
VAS: Ordering, Invoicing, Credit management, etc. built in the POS

Merchant lending based on anchors, merchant cash products in advanced stages of development

7: Merchant Development Program to aid MAB growth

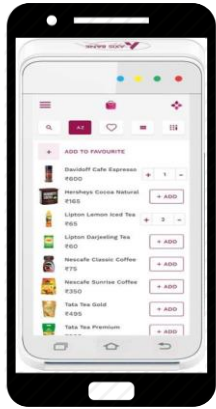

Catalog Management

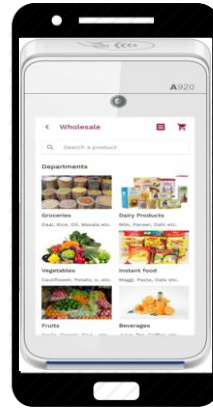

Purchase inventory from wholesalers

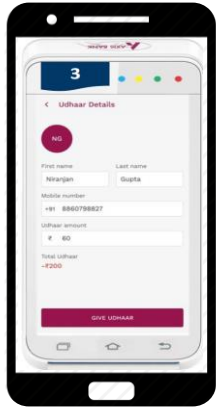

Merchant can manage the Udhhaar details of its customers

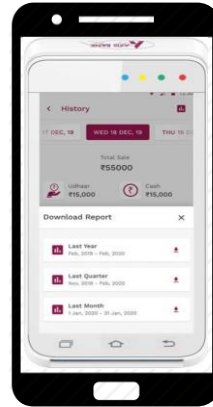

Transaction & GST ready reports



O

Pay later facility for Merchants with a 15 day credit period via POS

Zero balance **current account only for MDP merchants**

'Khaata' (reconciliation) functionality

P

Custom built functionalities such as Inventory module, catalogue management (Smart purchase recommendations for merchants)

E

Exclusive discounts from B2B ecommerce partners specially for merchants ordering through MDP POS on order & delivery

N

30% of eligible customers targeted for zero balance CA

Our digital strategy is aligned with our GPS strategy

A

Reimagine Customer Proposition



Digital-first products
embedding design thinking



End-to-end simplification of
customer journeys



Banking services **integrated**
across partner ecosystems



Omnichannel experience to
differentiate customer experience &
hyper personalization

B

Transform the Core



Ops excellence & institutionalization of
data & tech enabled operating rhythm



Twin-engine approach to build digital
stack and **modernize the core**



Modular, resilient technology with
cloud first architecture



Proprietary in-house capabilities for
accelerated design and go-to-market



Next gen **cyber security capabilities**

C

Build Future-ready Capabilities



Data architecture 3.0; moving beyond
analytical models to **data engineering**



Integrating **alternate, unconventional**
data for **risk-moderated growth**

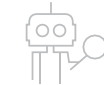

Digital workforce for
digital consumers

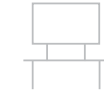

Creating a **cutting edge, future**
ready workspace 2.0

We are adopting a combination of approaches for the digital ecosystem

Build our own capabilities, partner with FinTechs where there is complementarity and invest in areas that have adjacencies



1: We are the 4th largest issuer of Credit Cards in the country

Featured Cards



Co-branded Cards



Premium Cards



Credit Cards in force (mn)

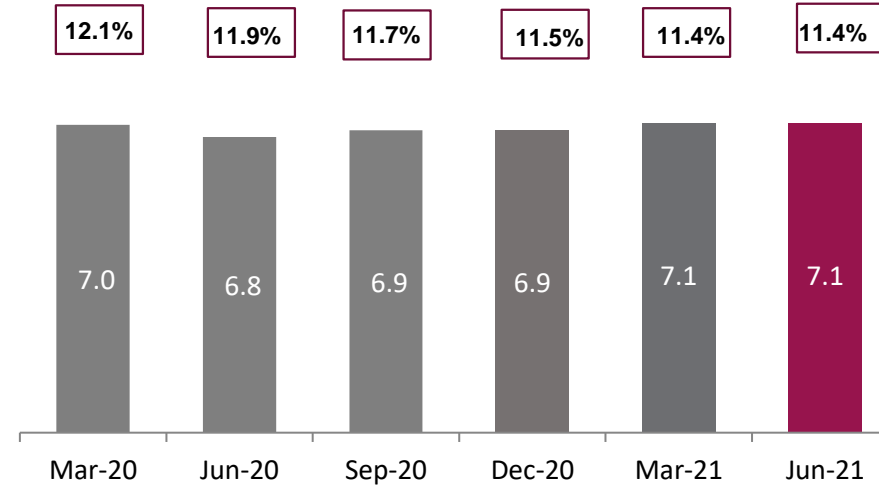

Credit Card market share and spends

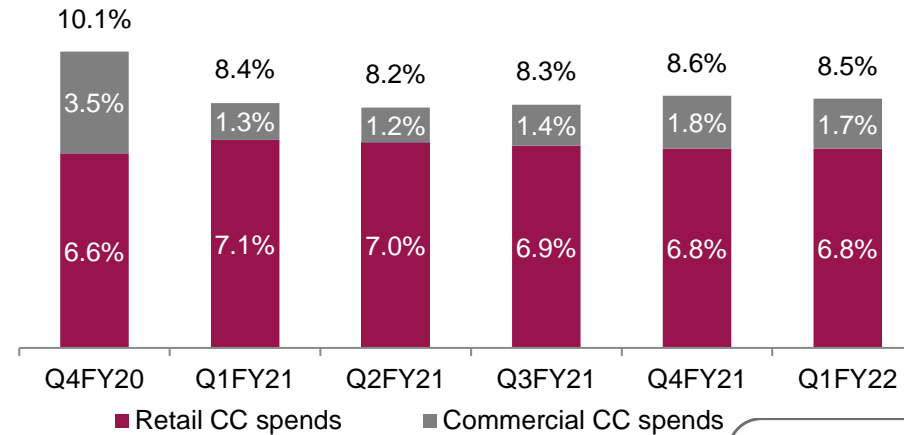

Source: RBI Data Reports

1: Flipkart Axis Bank Credit card | Acquisition journey

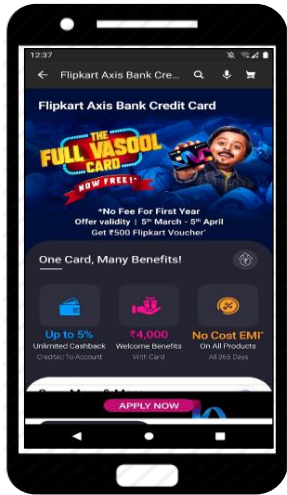

Customer clicks on Flipkart Axis Bank Credit card banner and can view details

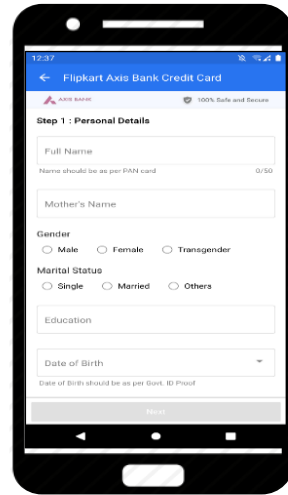

Customer fills up the form and submits the application

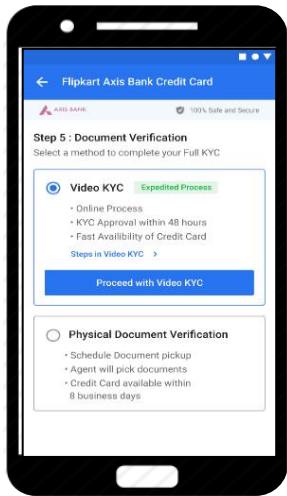

Approved customers complete KYC and income verification via digital or physical channels

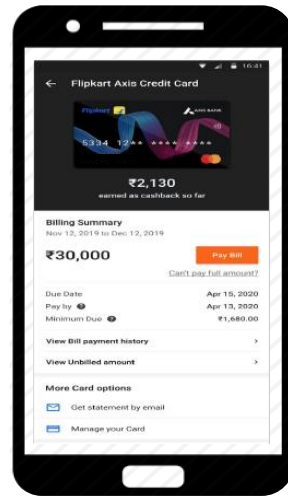

Card is generated and the customer can view and manage card features via Flipkart console

O Digital acquisition, fulfilment & servicing via partner platforms
Video KYC and Digitization of Income Documents to digitize application journey – *unique to Axis Bank*
10+ DIY card management features live on Flipkart

P API based digital journeys using Bank's onboarding and customer management platforms to deliver seamless experience

E Built in partnership with Flipkart and is being expanded across other partnerships

N 1.2Mn CIFs of the Flipkart Axis Bank Card

1: Flipkart Axis Bank Credit card | Card console

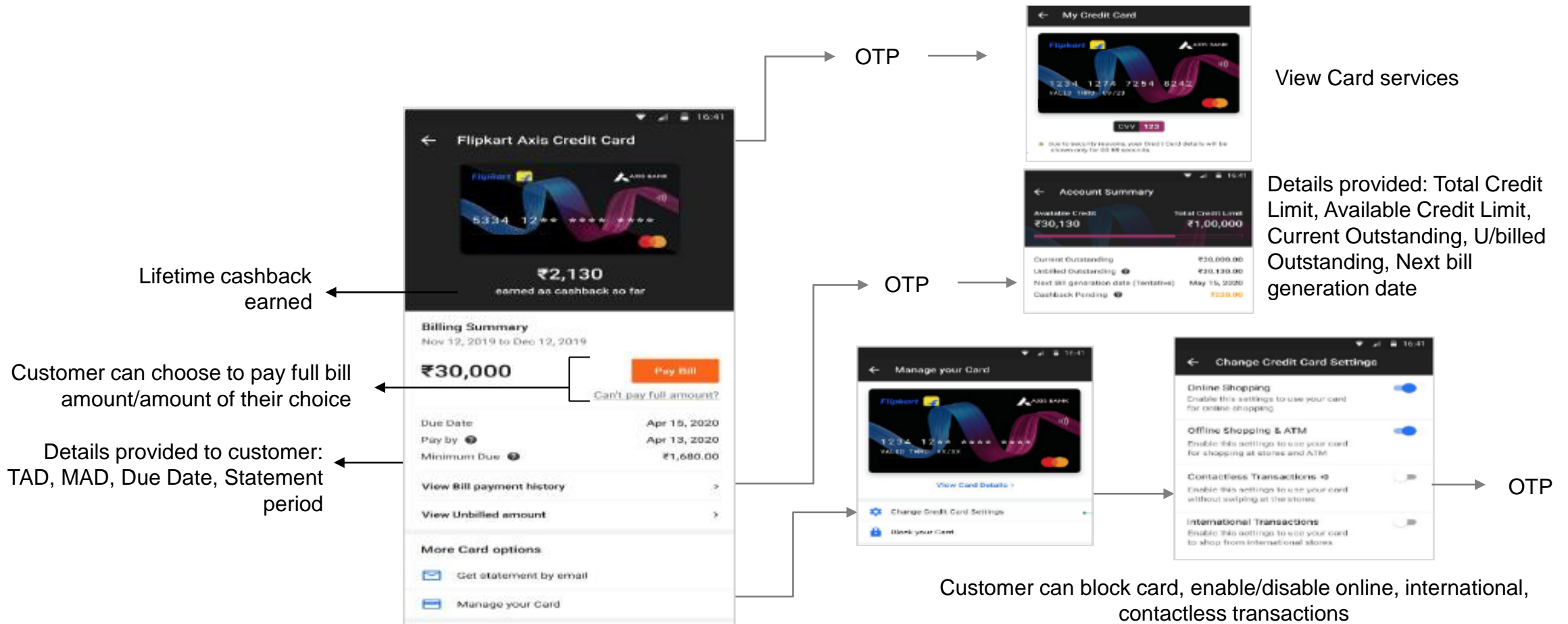

10+ DIY features on the Card Console on Flipkart App

1: Flipkart Axis Bank Credit card | Impact

Customer impact, Indexed

30 day Early activation

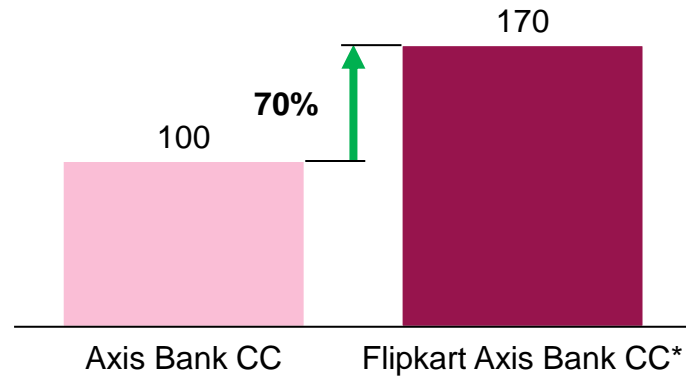

Monthly activity

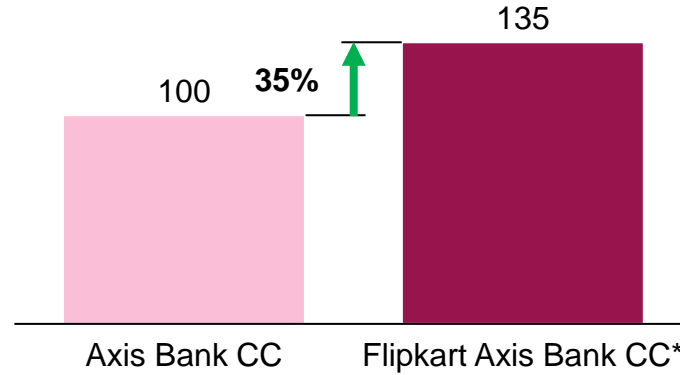

Financial impact, Indexed

Spends/open

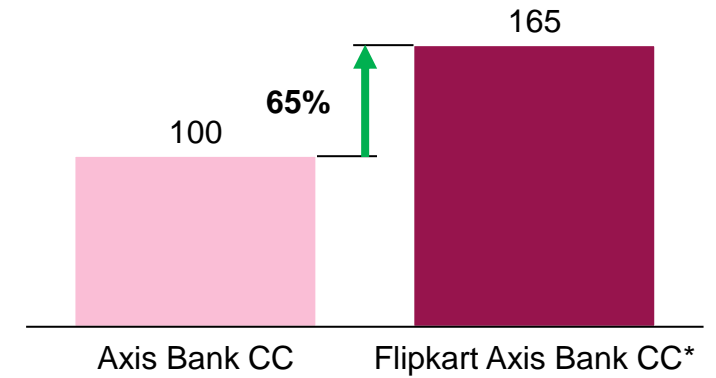

* Flipkart Axis Bank CC are the cards acquired via Flipkart platform
Note: Based on the aggregate data for the period Nov-20 to Apr-21

2: UPI | Growth Through Partnerships & Reliability



Powering **all major UPI TPAPs**



Acquiring Partnerships

- Axis Bank provides UPI acquiring services to leading online players – Amazon, CRED, Razorpay, PayU, Zerodha, Swiggy, BigBasket, Ola, Uber, BookMyShow, etc.
- In the offline space, we power acceptance via QR codes issued by Google, PhonePe and Freecharge among SMB merchants.



Focus on Reliability

- Pro-active investments in capacity building by setting up **dedicated UPI infrastructure and network bandwidth** – enabling peak volumes of up to 1400 TPS and reducing instances of technical declines

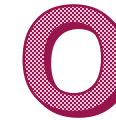

Instant on-boarding and creation of UPI handles allows customers to transact digitally within minutes.



Extensive suite of **UPI solutions (APIs and SDKs)** cater to all the digital payment needs of our partners



Leading player in the UPI ecosystem; among the first to partner with NPCI on new initiatives such as AutoPay, e-RUPI.



75%* growth in UPI transactions powered by Axis Bank YoY



2: UPI | Impact



UPI app volumes at 4x of nearest competitor



More than **9 lakh merchants** transacting per day on our stack



Acquiring more than **60 lakh daily** transactions for our merchants



Processing **40+ crore monthly** transactions as Payer PSP

Customer Impact

Indexed

Customer VPAs

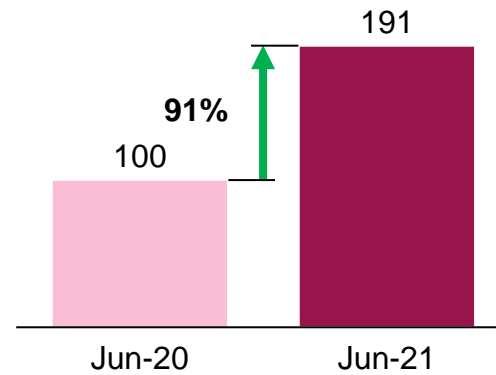

Payer PSP Market Share

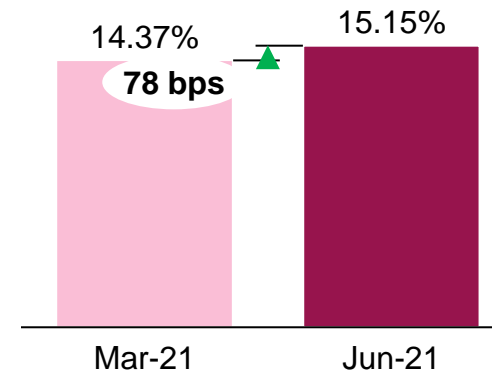

Successful Issuing Volume

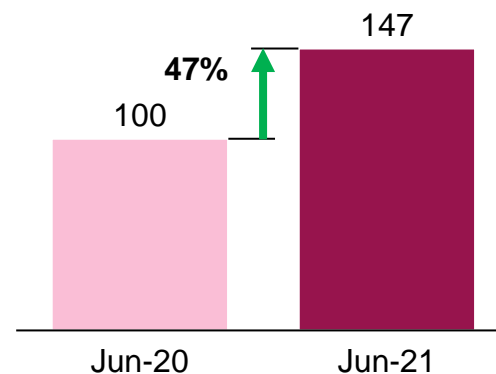

Acquiring Throughput

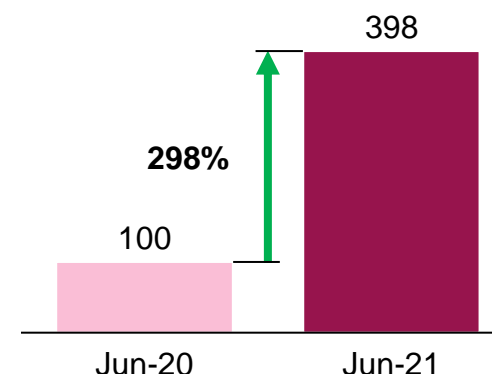

Operational Impact

Indexed

Remitter Technical Declines

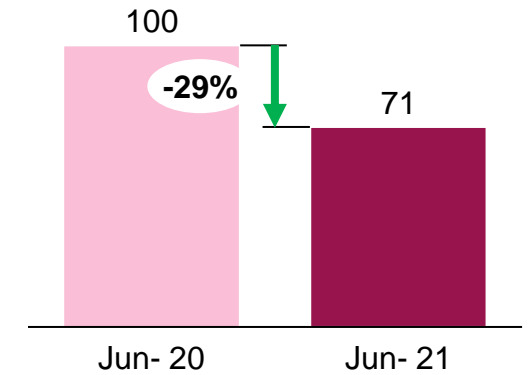

Remitter Technical Declines (Jun' 21) compared to Peer Banks

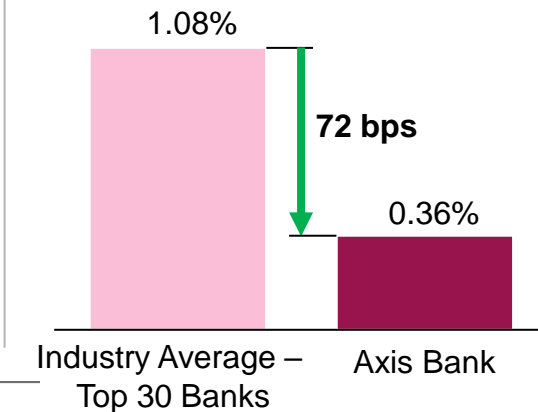

3: API Developer Portal

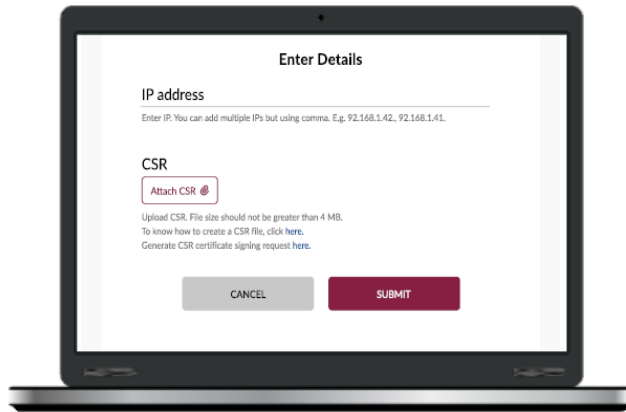

IP/CSR validation

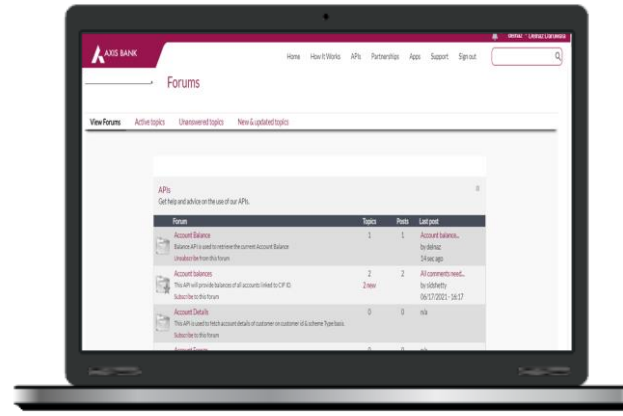

Developer community forum

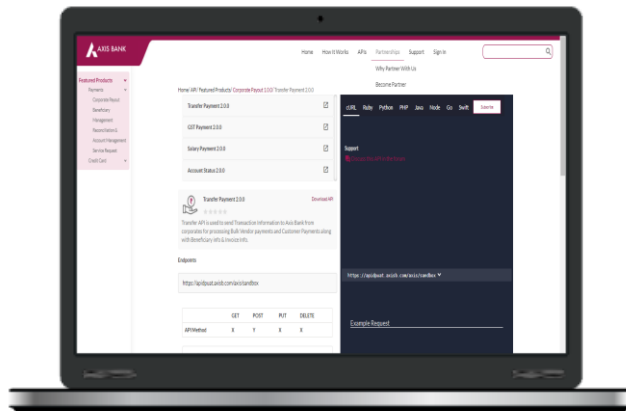

API documentation

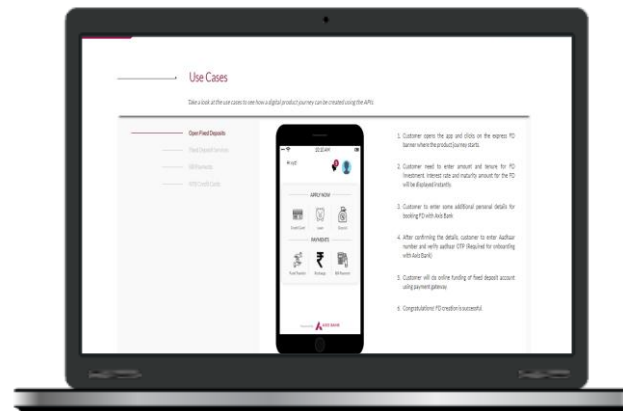

Use case journey

O

3 step process – Sign-up → Sandbox Testing → UAT
Off-The-Shelf use cases and journeys available for partners to go-to-market

P

Productization of APIs to offer easy Partner integration and superior customer-experience



E

APIs available in **multiple Technology Stacks** (Ruby, Python, Java, Node, Go, Swift, PHP) to cater to Partner Ecosystems
7 Partners onboarded

N

105% growth in no. of APIs in 3 months

<https://apiportal.axisbank.com/portal/>

3: API Developer Portal | Impact

Self registration

All developers can view and sandbox test Axis bank's APIs, simply by creating user ID and password

Notifications

Registered developers receive notifications for any new API uploads, structure updates, or journeys

Suggest your use case

Registered customers can suggest more APIs or use cases that they would like the Bank to offer

Customer impact

Sign-Ups (*Indexed*)

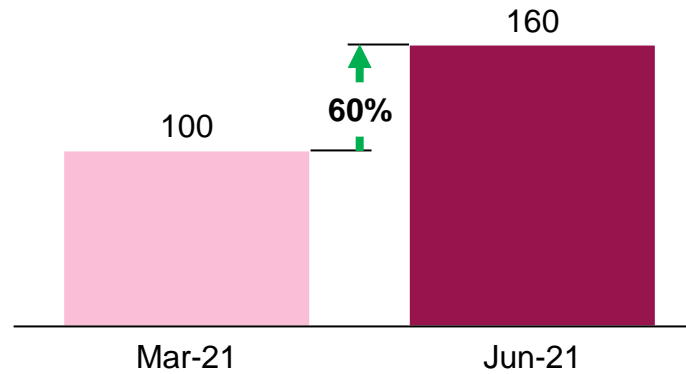

of visitors (*Indexed*)

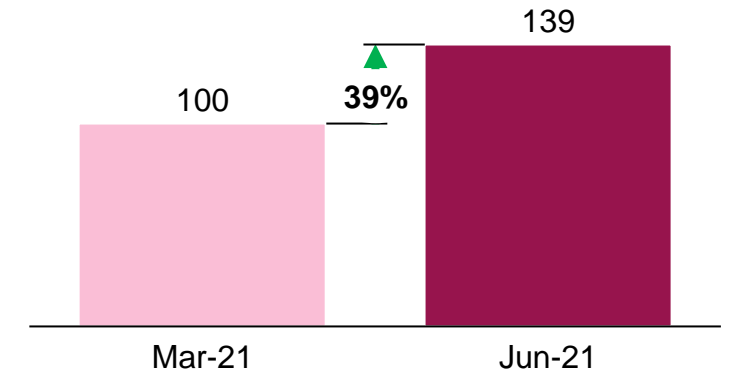

of APIs (*Indexed*)

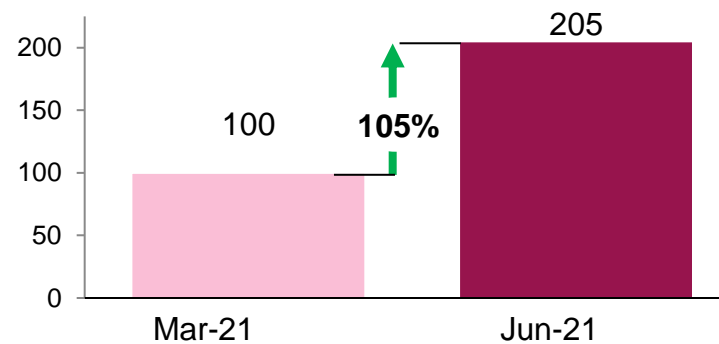

of products

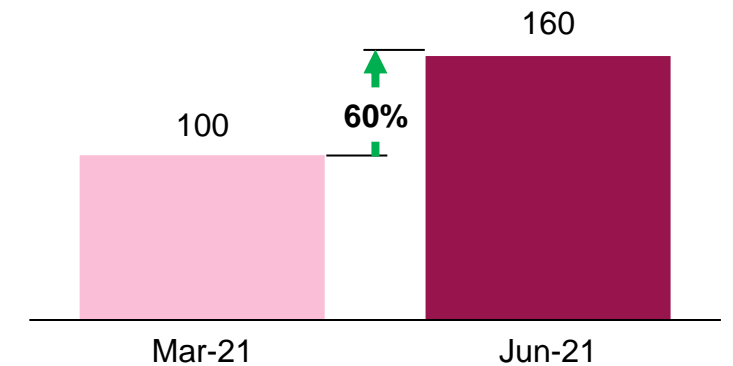

Our digital strategy is aligned with our GPS strategy

A

Reimagine Customer Proposition



Digital-first products
embedding design thinking



End-to-end simplification of
customer journeys



Banking services **integrated**
across partner ecosystems



Omnichannel experience to
differentiate customer experience &
hyper personalization

B

Transform the Core



Ops excellence & institutionalization of
data & tech enabled operating rhythm



Twin-engine approach to build digital
stack and **modernize the core**



Modular, resilient technology with
cloud first architecture



Proprietary in-house capabilities for
accelerated design and go-to-market



Next gen **cyber security capabilities**

C

Build Future-ready Capabilities



Data architecture 3.0; moving beyond
analytical models to **data engineering**



Integrating **alternate, unconventional**
data for **risk-moderated growth**



Digital workforce for
digital consumers



Creating a **cutting edge, future**
ready workspace 2.0

Our Mobile Banking volumes continue to grow



Axis Mobile is amongst the highest ranked Banking app on Apple Store (rating of 4.6) & Google Play Store (4.5) and offers 250+ DIY services

Axis Bank Mobile Banking Volumes (in Mn)

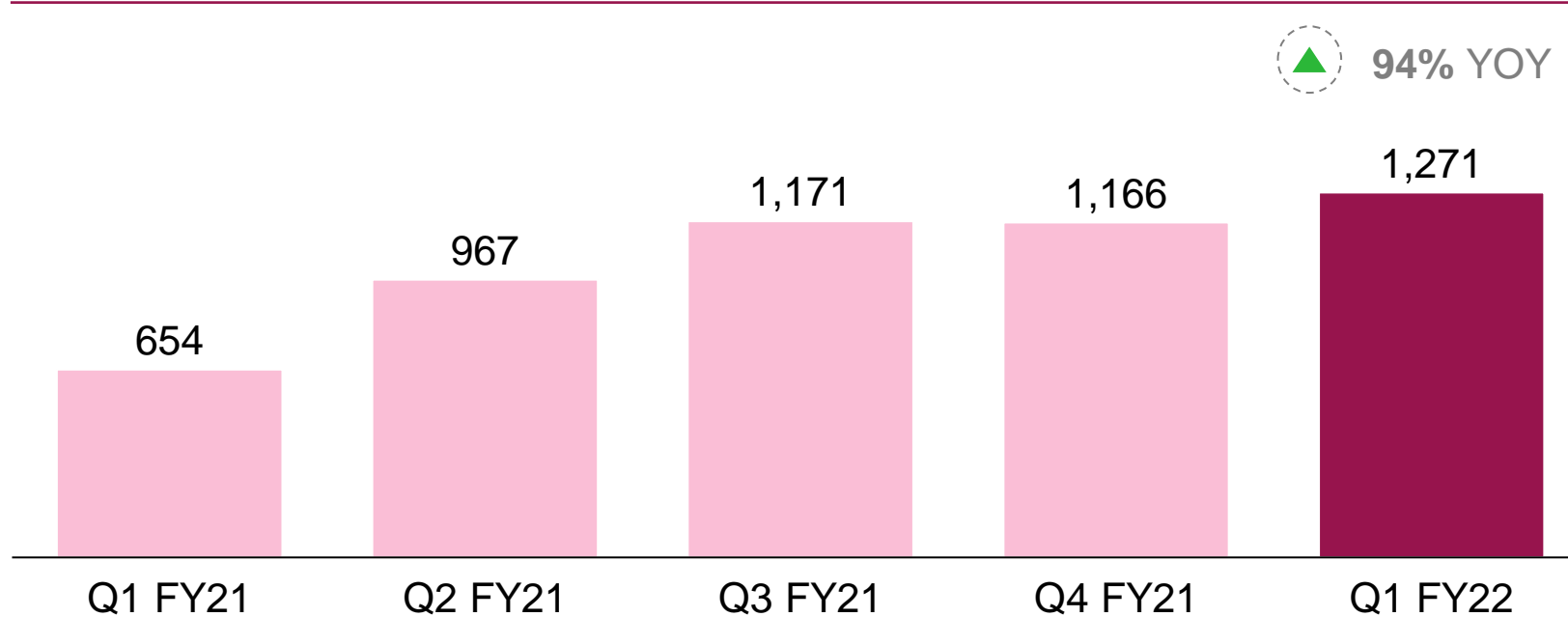

4 Mn non-Axis Bank customers using Axis Mobile & Axis Pay apps



Mobile Banking logins at **~16 times** Internet banking logins



Axis Aha! Chatbot answered **5.66 Mn** messages in Q1FY22



56% of Mobile Banking customers bank only on Mobile App

WhatsApp Banking emerging as a significant channel

Account Related

- Get your Account Balance
- Generate Account/Mini Statement
- Order Cheque Book

Credit Card Related

- Get your Outstanding Amount, Available Credit Limit
- Summary of Credit Card, Bill Payment details
- Block your Credit Card and many more to come.

What else you can do?

- Ask us Anything
- Get Pre-Approved Personal Loans in WhatsApp
- Apply for our Banking Products
- Locate Axis Bank Branches/ ATM and many more to come.

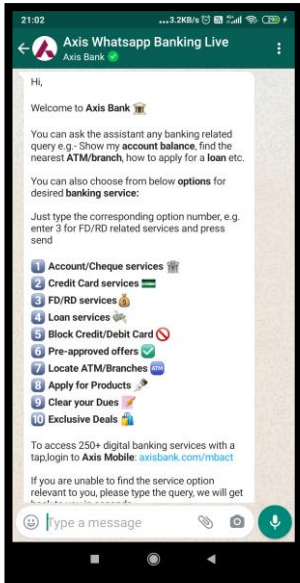

Comprehensive & simple menu option

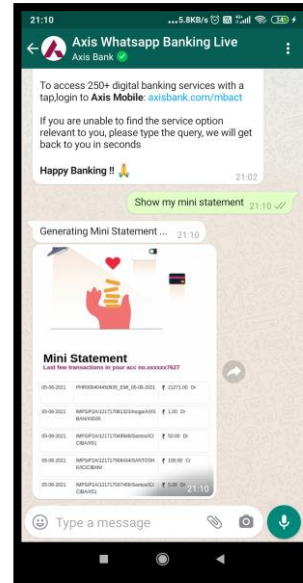

Rich cards to show better & simplified view

O

Insta Opt-In, real-time fulfilment of request on WhatsApp with **24x7 availability**
AI enabled Axis Aha integration to answer all FAQs

P

Hosted and managed on Axis Bank private cloud

E

Seamlessly integrated with WhatsApp for an almost native experience in customer's chat window

N

1mn customers onboarded
6mn+ customer interactions over last 6 months

WhatsApp Banking | Impact



6 months of successfully delivering banking services through WhatsApp



15

Total Services Live



1 Mn+

Unique Customer Opt-ins



6 Mn+

Customer Interactions



Account Level Enquiry

Requests

1.6 Mn+

Customers

0.6 Mn+



Credit Card Enquiry

0.8 Mn+

0.4 Mn+



FAQs Answered (via Aha!)

2.2 Mn+

0.8 Mn+

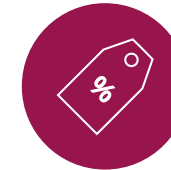

Pre Approved Offers

0.3 Mn+

0.2 Mn+



Axis Locations

76k+

43k+

Setting up best-in-class personalization engine to deliver distinctive customer experience...

Creating Digital DNA elements for more than **25 Mn** customers



CUSTOMER

- What is the current life stage of a customer? – *Married with kids*
- What does a customer do? – *Self Employed - Doctor*
- How much does the customer earn? – *143K per month*
- Where does the customer live? – *Tier 2 city*

Leverage DNA variables to understand the customer better & engage with them accordingly

Illustrative – Customer joined the bank as a student in 2013 and today as per the data, we can call her life stage to be **“Married with kids”**

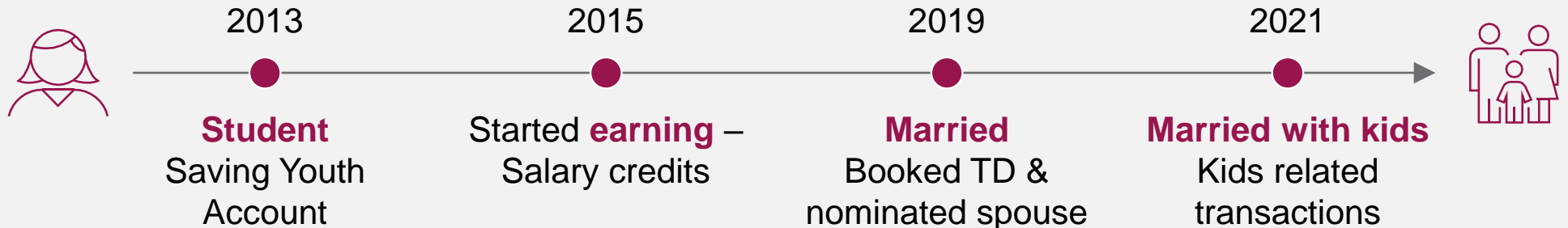

...by looking at 4 key dimensions when engaging with a customer

1

Customer Need

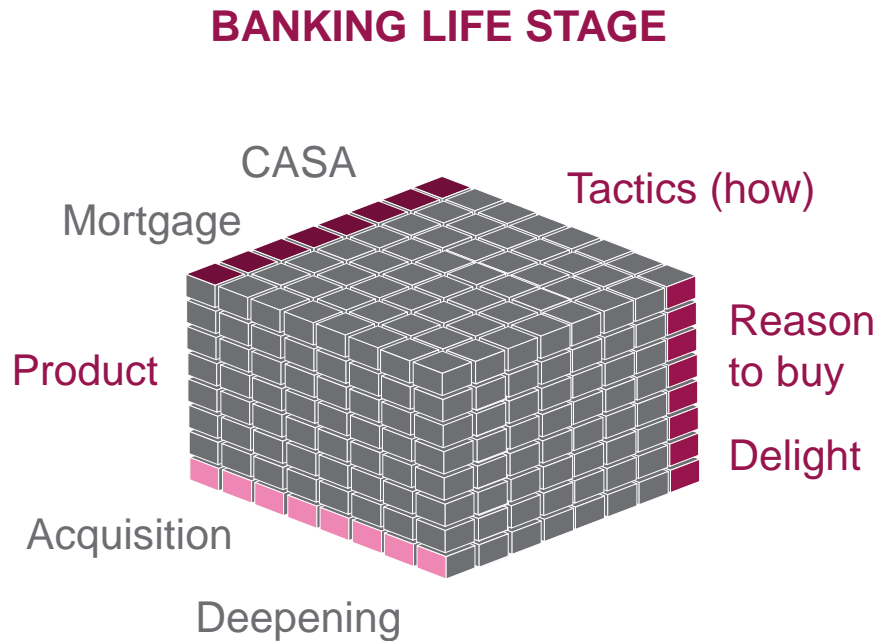

2

Offer

- Cash
- Voucher
- Experience
- Discount
- Loyalty
- Interest reduction
- Fee waiver
- Information/ knowledge
- Feel good message

3

Channel

Online/offline channels to be activated:

- Call center
- Stores
- Email
- Web
- App
- SMS

4

Message

-  Creative Imagery
-  Personal Connector
-  Contextual Text
-  Click Parameters

100+ nudges developed & deployed via custom cloud native serving layer

Leveraging situational triggers to craft a multistep curricula for ETB ...

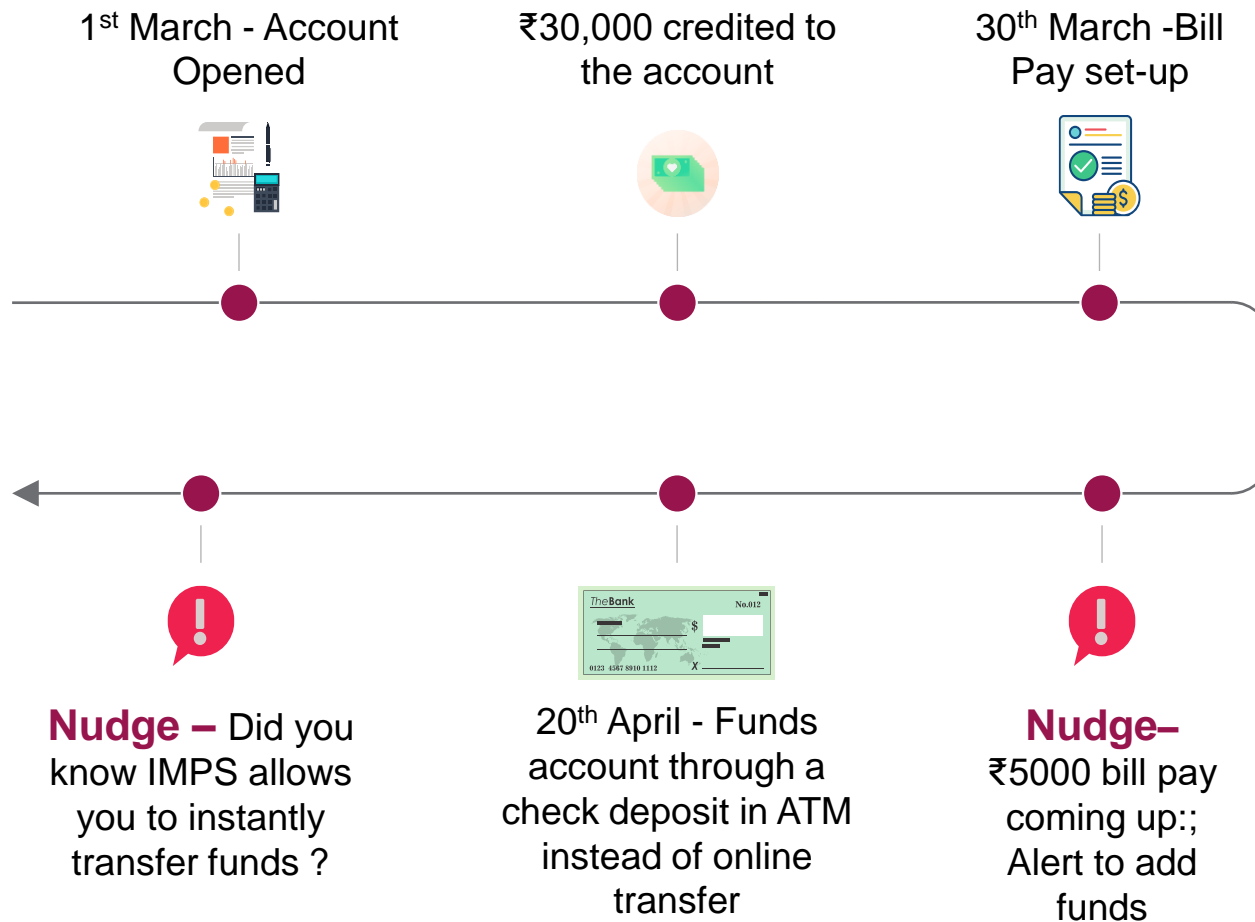

... & NTB to develop depth in engagement

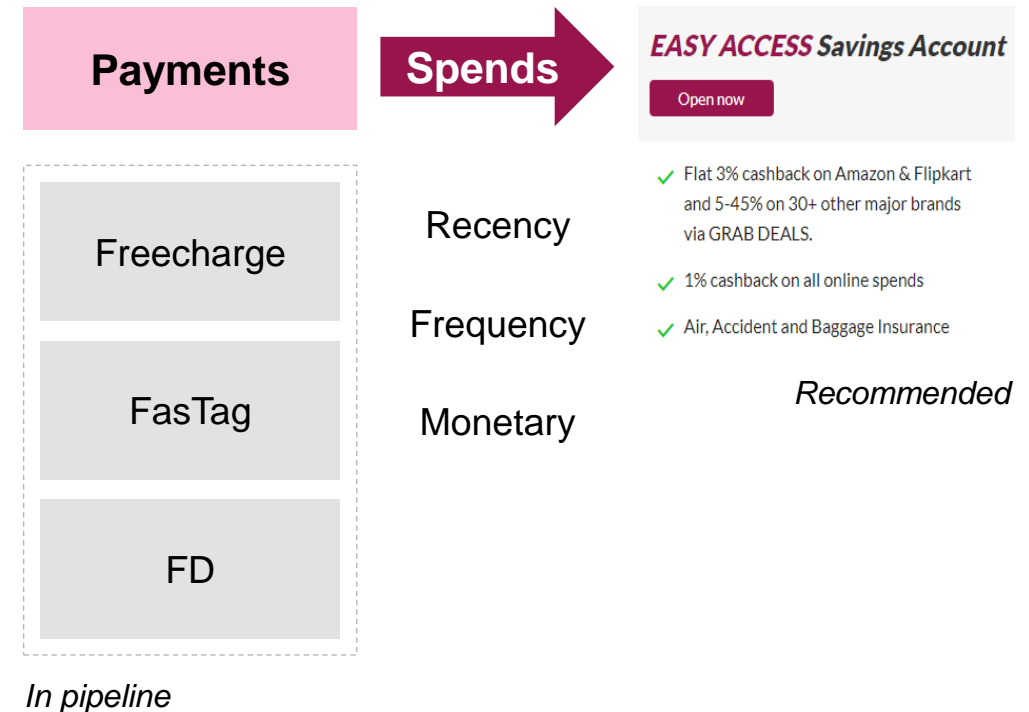

Our digital strategy is aligned with our GPS strategy

A

Reimagine Customer Proposition



Digital-first products embedding design thinking



End-to-end simplification of customer journeys



Banking services **integrated across partner ecosystems**



Omnichannel experience to differentiate customer experience & hyper personalization

**B**

Transform the Core



Ops excellence & institutionalization of data & tech enabled operating rhythm



Twin-engine approach to build digital stack and **modernize the core**



Modular, resilient technology with **cloud first** architecture



Proprietary in-house capabilities for accelerated design and go-to-market



Next gen **cyber security capabilities**

C

Build Future-ready Capabilities



Data architecture 3.0; moving beyond analytical models to **data engineering**



Integrating **alternate, unconventional data** for risk-moderated growth



Digital workforce for digital consumers



Creating a **cutting edge, future ready workspace 2.0**

Our digital strategy is aligned with our GPS strategy

A

Reimagine Customer Proposition



Digital-first products embedding design thinking



End-to-end simplification of customer journeys



Banking services **integrated across partner ecosystems**



Omnichannel experience to **differentiate** customer experience & **hyper personalization**

**B**

Transform the Core



Ops excellence & institutionalization of data & tech enabled operating rhythm



Twin-engine approach to build digital stack and **modernize the core**



Modular, resilient technology with **cloud first** architecture



Proprietary in-house capabilities for accelerated design and go-to-market



Next gen **cyber security capabilities**

C

Build Future-ready Capabilities



Data architecture 3.0; moving beyond analytical models to **data engineering**



Integrating **alternate, unconventional data** for risk-moderated growth



Digital workforce for digital consumers



Creating a **cutting edge, future ready workspace 2.0**

1: Branch of the Future | Transform the way Axis Bank engages with and serves its customers

Re-engineer key service requests to **release frontline capacity** from servicing and enable **focus on relationship building** & sales

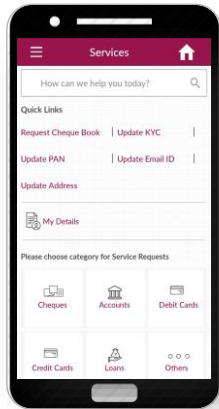

Customer clicks on Update Address

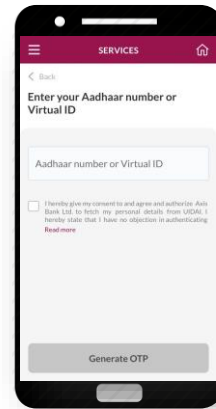

Enters Aadhaar number and OTP for authentication

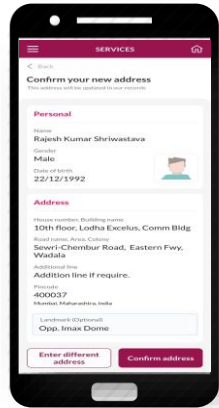

Confirms the details fetched from UIDAI

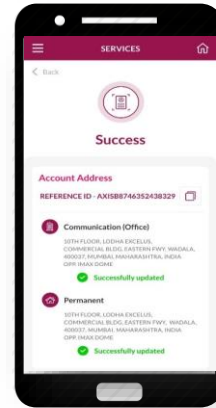

Request is processed and customer is shown a Success screen

50+ Initiatives identified and underway

O

250+ services available digitally – amongst the highest in industry

Only Bank to provide OCR based document classification, Instant demographics updation through Aadhaar

P

A proprietary **cloud** solution that's **integrated with all core bank systems** for real time processing of service requests

E

Easy to integrate with other non-digital channels to provide an **omni-channel experience** to customers

N

90%+ digital requests processed real time via straight through processing

~20% time saving for tellers and BROs targeted

1: Branch of the Future | Impact

Services accounting for
~65%
of request volumes in
branches are now
digitally available

**Aggregated
metrics**

90%+
STP rate

<1%
NFTR rate

58%*
Digital adoption

Updation of PAN service request illustration

STP increased by

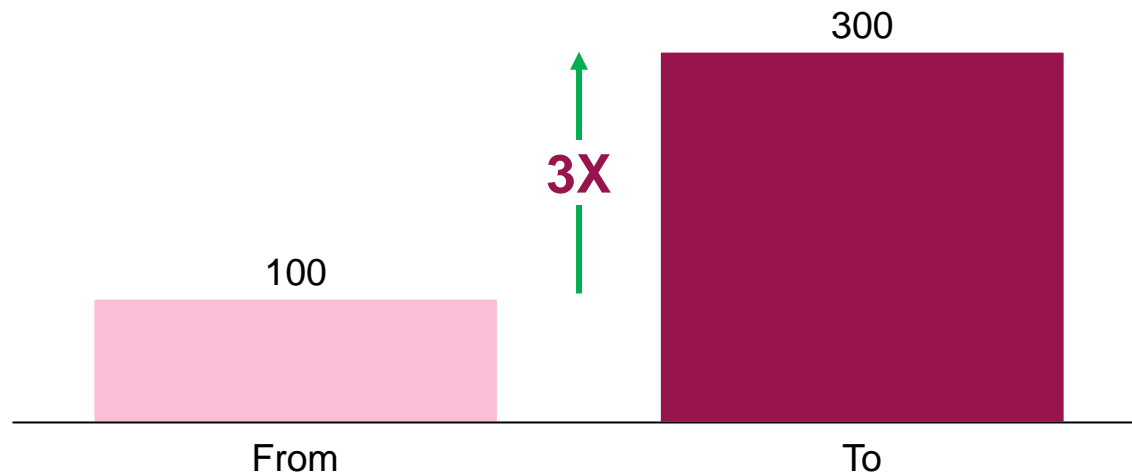

NFTR reduced by

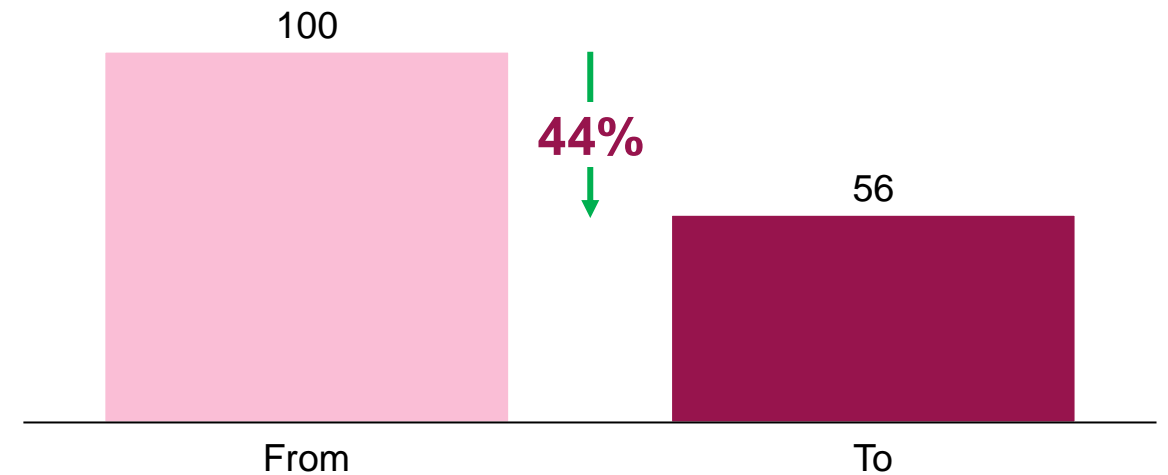

*Digital adoption is basis requests processed through digital and branch channels in Jun'21 for services that take up max vol in branches
STP and NFTR is for requests processed through digital channels in Jun'21 for 13 services built under BOF

2: Operations transformation | Back-office productivity enhancement



Results for FY21: 30+ large-scale operations transformation projects, multiple medium-scale initiatives (Gati) and continuous improvement initiatives (Pragati) were delivered across customer life cycles and internal controls.

3x increase in **STP** of service requests
90% improvement in **NFTR**
75% improvement in **TAT of NSTP** processes
 Implemented system to track and close service requests for wholesale banking

Establishment of an **Intelligent Automation Center**
4X increase in Number of interventions over cumulative baseline
3X increase in automation index of operation teams

Institutionalized digital transactional (**Risk & Fraud**) monitoring
 Leveraging analytics to **enhance customer satisfaction and improve efficiency**

Lean Six Sigma training for project members
Skills development initiated in analytics, customer experience, portal development, and dissemination tools
Automation of manual reports and MIS





The Bank has achieved its customer experience targets for FY 21

3: Sankalp | Technology led transformation benefitting CBG business on sales effectiveness and credit process

Sankalp Sales app



Sankalp credit process

Design principles for the re-imagined credit process		Impact
 <p>Differentiated Scorecard determined swimlane basis risk & complexity; Diligence and documentation processes well-differentiated across swimlanes</p>		60% + Reduction in documents required
 <p>Digital first Digital collection and processing of documents / information</p>		30 mins for pre-screening vs. 1 day
 <p>Parameterized evaluation Data and scorecard driven underwriting approach</p> <ul style="list-style-type: none"> • Prepopulated data • Improved quality by augmenting credit with digitally generated insights 		2x Increase in Asset productivity of RM (no. of new NTB NOAs opened / month)
 <p>Empowerment Higher decisioning rights at geography with streamlined deviation culture</p>		39% YOY Growth in asset NTB accounts opened in Q1FY22
 <p>Collaboration and Transparent All stakeholders on single platform</p>		18% YOY Growth in CBG Advances

4: Siddhi | Tool for sales and managerial effectiveness

Intelligent, comprehensive, proactive and hyper-personalized employee tool that enables meaningful customer conversations via analytics and empower managers to have control and meaningful coaching conversations

Problem statement

Varied customer experience during sales and service due to poor frontline knowledge, skills

Relatively **low and uneven frontline productivity** due to lack of structured sales process and limited central enablement

Poor employee experience due to fragmentation of applications, clunky communication, information asymmetry

Tough external environment requiring maximization of value from current assets

Design principles



Intelligent: Predictive ability, insights

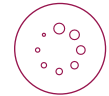

Comprehensive: Customer 360, single access



Proactive: Nudges for improved customer connects



Personalized: Self-optimizes

Implementation and impact

MVP 1 across 5 journeys (Customer Interaction, Day Planning, Performance Management, Team Management, Training)

Addressing **premium portfolio** (Priority, Burgundy and NRI) covering **3,000** RMs

Further drops across branch roles, Retail Assets and Mid-corporate RMs in design phase

300+

Staff journeys across Bank and subsidiaries

Reduced

Opex and capex for the Bank while delivering better frontline productivity

5: We have also transformed our internal processes to empower our employees and enhance effectiveness

BYOD



Bring Your Own Device (BYOD) program, enabling staff to use bank apps on their devices thereby enhancing staff mobility, productivity and improvement in TAT



60,000+

Staff onboarded



~350K

Leads delivered
per month



400+

Compatible models/
OS flavours



7%

NFTR rate with AI, OCR,
facial recognition, and
geo co-ordinates tracking

Our digital strategy is aligned with our GPS strategy

A

Reimagine Customer Proposition



Digital-first products embedding design thinking



End-to-end simplification of customer journeys



Banking services **integrated across partner ecosystems**



Omnichannel experience to differentiate customer experience & hyper personalization

**B**

Transform the Core



Ops excellence & institutionalization of data & tech enabled operating rhythm



Twin-engine approach to build digital stack and **modernize the core**



Modular, resilient technology with **cloud first** architecture



Proprietary in-house capabilities for accelerated design and go-to-market



Next gen **cyber security capabilities**

C

Build Future-ready Capabilities



Data architecture 3.0; moving beyond analytical models to **data engineering**



Integrating **alternate, unconventional data** for risk-moderated growth



Digital workforce for digital consumers



Creating a **cutting edge, future ready workspace 2.0**

A twin-engine approach to upgrade legacy IT stack to make it digital ready and build a best-in-class end-to-end digital stack

Build Digital

- New age digital platforms
- Cloud first
- Decoupled Engagement layer & Logic layer
- Micro services enabled

Twin Engine Approach



Modernize the Core

- Upgrade of Tech-stack
- Focus on modernizing the core, resiliency, sustainability, risk and governance
- Transform architecture, core systems, infrastructure and integration

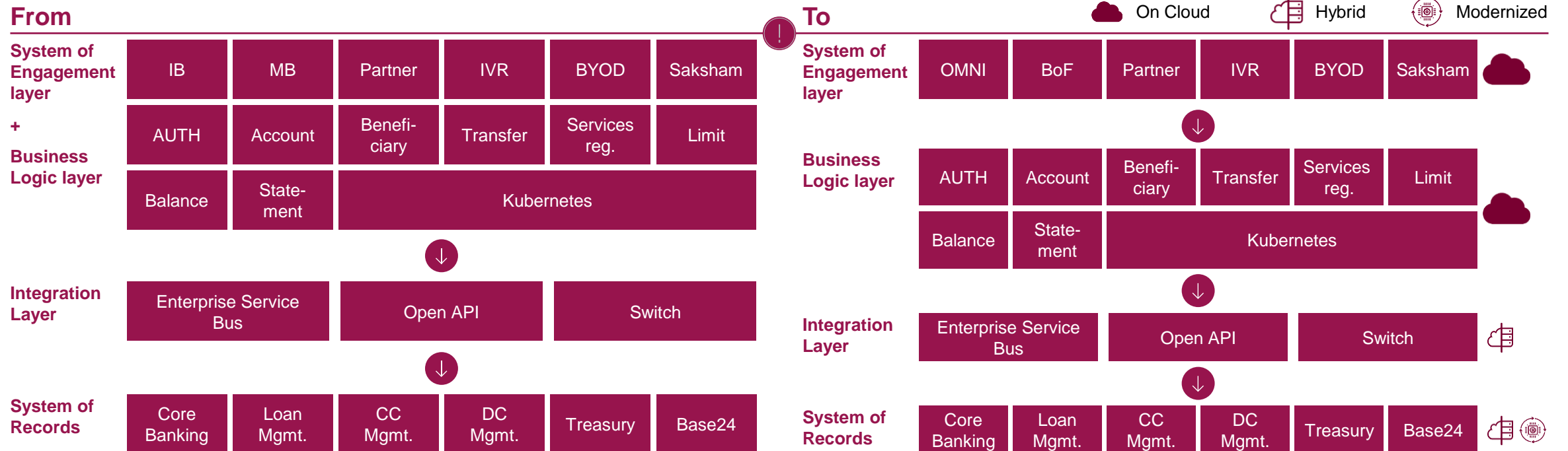

Our digital strategy is aligned with our GPS strategy

A

Reimagine Customer Proposition



Digital-first products embedding design thinking



End-to-end simplification of customer journeys



Banking services **integrated across partner ecosystems**



Omnichannel experience to **differentiate** customer experience & **hyper personalization**

**B**

Transform the Core



Ops excellence & institutionalization of data & tech enabled operating rhythm



Twin-engine approach to build digital stack and **modernize the core**



Modular, resilient technology with **cloud first** architecture



Proprietary in-house capabilities for accelerated design and go-to-market



Next gen **cyber security capabilities**

C

Build Future-ready Capabilities



Data architecture 3.0; moving beyond analytical models to **data engineering**



Integrating **alternate, unconventional data** for risk-moderated growth



Digital workforce for digital consumers



Creating a **cutting edge, future ready workspace 2.0**

1: We are the leader in cloud adoption in the banking sector

Why cloud was vital in Axis Bank's transformation agenda

By Rajiv Bhuva | June 29, 2021



Amitabh Chaudhry, Managing Director and CEO of Axis Bank, on the bank's core transformation strategy—and the future of banking.

mint

Axis Bank chooses AWS to transform digital experience



Axis Bank will use AWS to build new digital services. mint (Photo: Mint)

moneycontrol

Axis Bank inks multi-year deal with AWS for powering digital banking services

As part of the agreement, Axis Bank will draw on the breadth and depth of AWS services to build a portfolio of new digital financial services to bring advanced banking experiences to customers, including online accounts that can be opened in under six minutes and instant digital payments.



Business Standard

Axis Bank strikes cloud computing deal with AWS for digital transformation

India's third-largest private sector bank to migrate 70% of its on-premises data centre infra in next 24 months to further reduce cost, improve agility, improve customer experience

Axis Bank to send 70% of its apps and infrastructure to the cloud

The Indian bank turns to AWS for digital banking transformation.

By Asha Barbaschow | June 30, 2021 - 01:01 GMT (06:31 IST) | Topic: Cloud

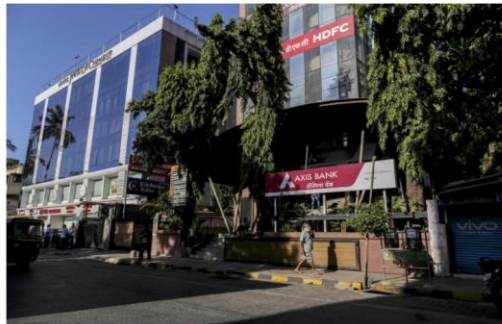

Watch: How Covid-19 made Axis Bank think digital and cloud-first

Anand J | 20 Aug, 2020



As India went into lockdown to contain the Covid-19 crisis in March, the country's third-largest private sector lender Axis Bank moved swiftly to ensure that employees have access to critical applications to maintain business continuity.

2: 500 deployments in CI/CD mode through the 'Jenkins' pipeline

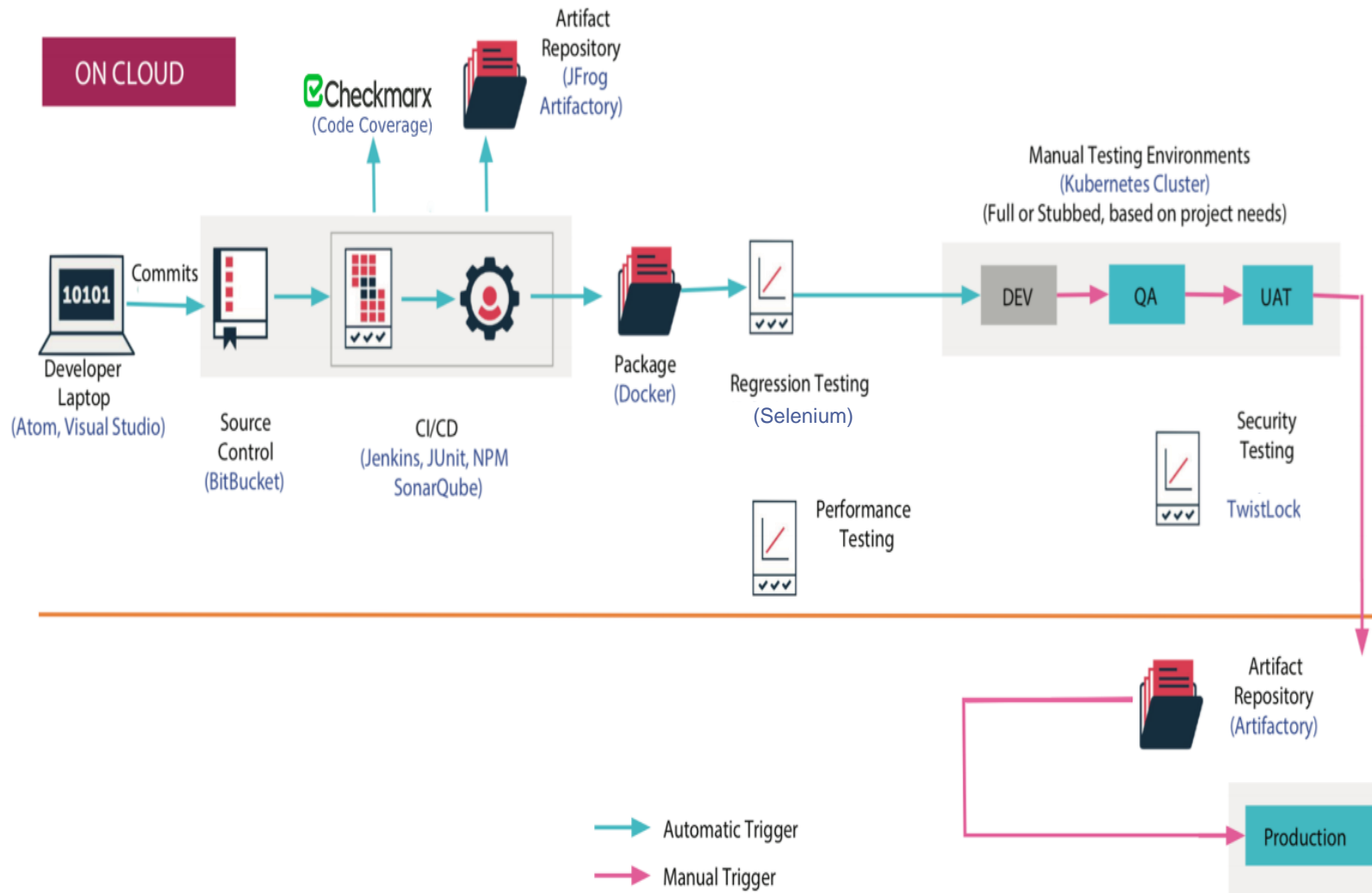

The **DevSecOps Build Farm** for Axis is capable of handling **multi cloud CI CD**

All security tools have **embedded security tolerance**

Platform supports the entire spectrum from **monolithic deployment** in traditional application servers to **cutting edge deployment in managed services Kubernetes**

Features like ChatOps, automated functional and non functional testing are in the pipeline to evolve it to a **truly touchless CI CD platform**

3: Resiliency at Axis being built through multiple initiatives

Built for Resiliency



Data Centre

Data Centers Expansion
DRM solution implemented
DR drill calendar for Apps



New Age Tech.

Adoption of SDN, Latest Enterprise Class Storage, HCI, Cloud, Engineered Systems, Tapeless Backup



Data

Maximum availability arch.
Always on methodology

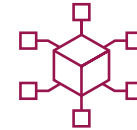

Network

N+N Arch. for critical n/w components and dynamic routing protocols



Cloud

Cloud Platform & Technologies adoption with **~50** Apps live from Cloud



Standardization

Infra Standardization covering Hardware & Software tech



Monitoring

24x7 Resiliency Operation and Network Operating Centre monitoring using NMS Tools



Assessments

Business impact analysis, data center and app resiliency audits

Continuous Technology Refresh - Year-on-year >25% Refresh towards Latest Technology Adoption



Continuous Re-skilling - Technology adoption of techniques like SRE, Technology Labs etc.

Governance - IT Strategy of the Board, Management Reviews



Key focus areas

3: Strengthening to become Best-in-Class data infrastructure

 <p>Data Centres</p>	<p>Near DR¹ for Critical Apps</p>	<p>4 Physical data centres</p>	<p>100% Infra ~3 Year ageing</p>	<p>RTO² reduced by 50% for critical applications</p>	<p>Improved Infra availability from 99.99% to 99.999%</p>
	<p>Software defined single-pane management with orchestration</p>	<p>Near Zero Data Loss architecture</p>	<p>Standardized Hardware, OS & DB to Latest Tech/Platform</p>	<p>Software defined single-pane management with orchestration for network</p>	
 <p>Applications</p>	<p>Near Zero RPO³ for Critical Apps</p>	<p>Monitoring Customer-level application performance</p>	<p>Proactive approach to improve App Resiliency to 99.999%</p>	<p>70% Apps on Cloud targeted in 3 Years period</p>	<p>Skillset readiness for Cloud tech (Kubernetes, Containers, In-memory, Functions & Sharding)</p>
 <p>Service Delivery</p>	<p>Improved assurance of repeatable tasks</p>	<p>Improved reliability in Biz Services delivery</p>	<p>Reduce human intervention & errors</p>	<p>ITIL Framework implementation</p>	<p>Site reliability engineering (SRE) framework</p>

1. DR – Disaster Recovery 2. Recovery Time Objective 3. Recovery Point Objective

Our digital strategy is aligned with our GPS strategy

A

Reimagine Customer Proposition



Digital-first products embedding design thinking



End-to-end simplification of customer journeys



Banking services **integrated across partner ecosystems**



Omnichannel experience to differentiate customer experience & hyper personalization

B

Transform the Core



Ops excellence & institutionalization of data & tech enabled operating rhythm



Twin-engine approach to build digital stack and **modernize the core**



Modular, resilient technology with **cloud first** architecture



Proprietary in-house capabilities for accelerated design and go-to-market



Next gen **cyber security capabilities**

C

Build Future-ready Capabilities



Data architecture 3.0; moving beyond analytical models to **data engineering**



Integrating **alternate, unconventional data** for risk-moderated growth



Digital workforce for digital consumers



Creating a **cutting edge, future ready workspace 2.0**

Developing in-house tech, design and AI capabilities

The Bank is focusing on developing its in-house capabilities

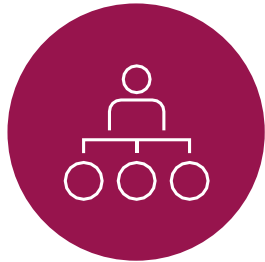

Enterprise Architecture Practice that focuses on building a **sustainable governance structure to rationalize and optimize** the application architecture



Agile Centre of Excellence (CoE) to build capabilities to deliver faster
Key roles such as **Agile Coach, Scrum Master** are being introduced across IT projects to drive adoption and leverage benefits



Customer Experience will be a **focal point** of all technology developments and enhancements and therefore, Bank has invested on experienced talent in this area
Subzero design - a collection of guidelines and components to create a unified experience for all Axis Bank customers

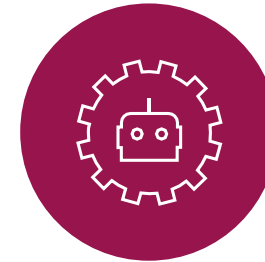

IA center of excellence (CoE) to create overall automation strategy and adoption of industry practices enabling **scaling automation** and maximize benefits within the bank and its subsidiaries

66% increase in the IT team strength in the last 2 years

1: Sub-zero design platform for a unified user experience

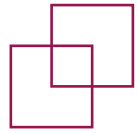

Subzero is a collection of guidelines and components shared among designers and developers in order to create a streamlined and enjoyable user experience for all Axis Bank customers.



At its centre is the pattern library which contains reusable components and foundations, from the individual atoms to the full templates and pages..



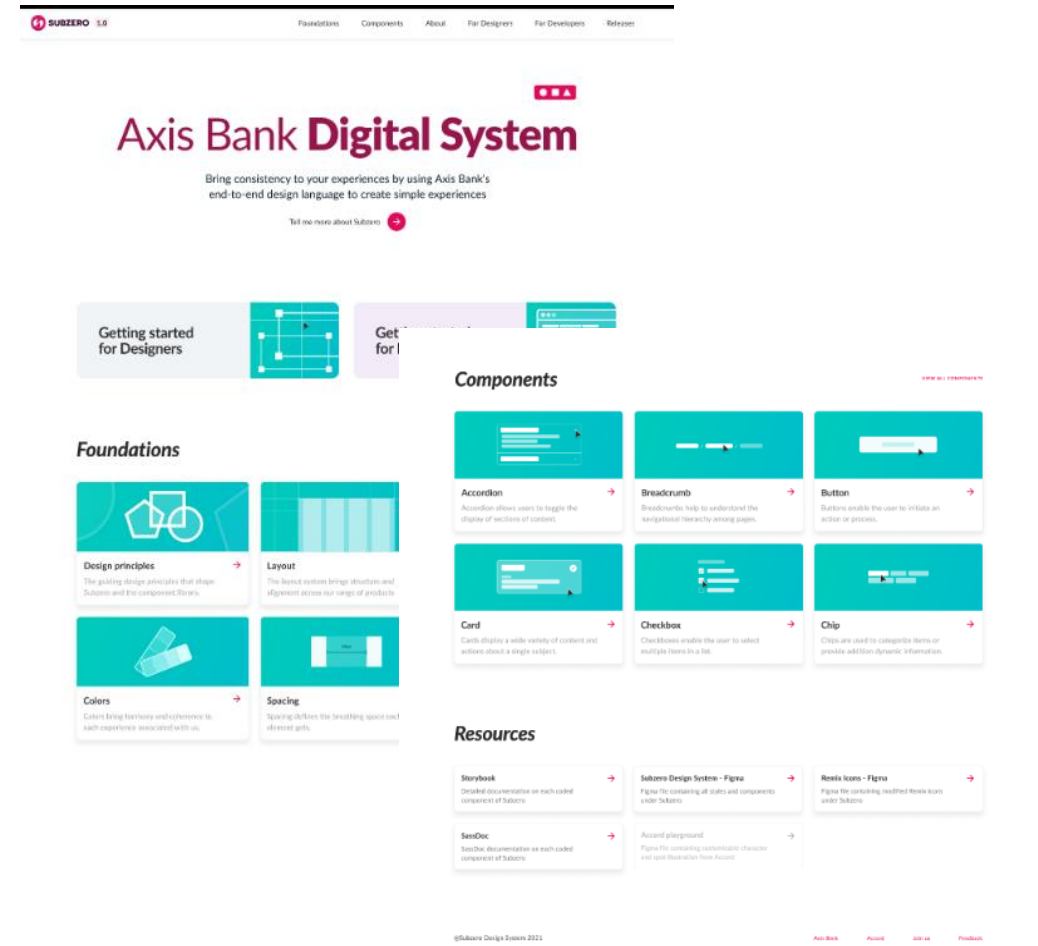

Rather than focusing on pixels, developers can focus on application logic, while designers can focus on user experience, interactions, and flows.

Subzero will help reduce design and development time by ~20%, and provide consistency across customer journeys





2: IA center of excellence (CoE) to create overall automation strategy and adoption of industry practices (1/2)

IA journey so far

Key streams	Implemented interventions	Success stories
RPA	650+	<p>Digital Insta Services – Using AI & OCR for KYC document validation & Aadhaar redaction leading</p> <p> 40% NFTR Reduction due to the pre-upload check</p>
AI/Cognitive automation	50+	<p>Email BOT – helps in automating understanding of content, issue prioritisation, routing and revert generation for incoming emails</p> <p> 70% intent identification</p> <p>40% reduction in average handling time</p>

FY 22 focus areas

Intelligent customer engagement 	Paperless journey 	Digital assurance 
<p>Conversational AI</p> <ul style="list-style-type: none"> Use of Voice BOT to automate call handling for outbound calls for sales/reminders/notifications <p>Speech analytics to assist agents real time & automate call quality assessments</p> <ul style="list-style-type: none"> Chat BOT 	<p>Customer experience improvement</p> <p>Attended Bot (personal RPA BOTs who help with daily repetitive tasks)</p> <ul style="list-style-type: none"> Computer vision Use of IOCR technology to extract information for processing and machine learning 	<p>Automating controls to reduce risks</p> <p>Creation of automated control reports for risk mitigation along with assurance functions</p>

2: IA center of excellence (CoE) to create overall automation strategy and adoption of industry practices (2/2)

Four levers for CoE institutionalization

- | | |
|--------------------------------------|--|
| 1 Structure & governance | Operating model, roles and responsibilities
Delivery practices and governance framework |
| 2 Partners & tools | Tool and cloud strategy
License optimization and Partner engagements
Platform consolidation |
| 3 Capability & competence | Setup of IA specialist roles & capabilities
Learning and development plan for IA roles |
| 4 Delivery and maintenance | Agile transformation for delivery
Automate process performance review and reporting
Setup of Business Continuity practices |



Our digital strategy is aligned with our GPS strategy

A

Reimagine Customer Proposition



Digital-first products embedding design thinking



End-to-end simplification of customer journeys



Banking services **integrated across partner ecosystems**



Omnichannel experience to differentiate customer experience & hyper personalization

**B**

Transform the Core



Ops excellence & institutionalization of data & tech enabled operating rhythm



Twin-engine approach to build digital stack and **modernize the core**



Modular, resilient technology with **cloud first** architecture



Proprietary in-house capabilities for accelerated design and go-to-market



Next gen **cyber security capabilities**

C

Build Future-ready Capabilities



Data architecture 3.0; moving beyond analytical models to **data engineering**



Integrating **alternate, unconventional data** for risk-moderated growth



Digital workforce for digital consumers



Creating a **cutting edge, future ready workspace 2.0**

Committed to Highest Standards of Data Security and Customer Privacy (1/2)

Security by Design



Defence in depth through best in class security technology and process controls



Vulnerability and threat management across the entire tech. landscape



24 x 7 events monitoring by SOC through Next Gen SIEM, threat intelligence tools



Continuous RED Team exercises to proactively and timely vulnerability identification



Continuous transaction monitoring supplemented by real-time decline rules



Strengthening Cyber resilience program with focus on detect and respond/recover activities



Security Analytics for enhanced security threat visibility



780 / 900
Bitsight Rating¹

1. BitSight Rating = Key Risk Indicator of Over all Cyber Security. Cybersecurity ratings company based in Boston, US (2011). Approach similar to credit ratings for financial risk. BitSight Security Ratings are calculated on a scale of 250-900 with a higher rating indicating better security performance.

Committed to Highest Standards of Data Security and Customer Privacy (2/2)

Key Capabilities



In-House Cyber Breach Assessment

For safely simulating multiphase, real-world attacks, and identify gaps / vulnerabilities in Bank's environment.



24x7 Dark Web Monitoring

- a. Fraudulent / Phishing sites
- b. Artificial Intelligence based Digital Risk Monitoring for Bank's sensitive data on Internet / Dark web



Cyber Security Threat Intelligence from best-in-class commercial sources



Cloud Cyber Security Suite

Container security monitoring & vulnerability Scanning

Cloud security compliance monitoring



Cyber Security controls for DevSecOps Pipeline

Static analysis

Dynamic analysis

Real-time vulnerability monitoring and analysis

Cloud container image signing

Cloud secret keys and credential management

Our digital strategy is aligned with our GPS strategy

A

Reimagine Customer Proposition



Digital-first products embedding design thinking



End-to-end simplification of customer journeys



Banking services **integrated across partner ecosystems**



Omnichannel experience to **differentiate** customer experience & **hyper personalization**

B

Transform the Core



Ops excellence & institutionalization of data & tech enabled operating rhythm



Twin-engine approach to build digital stack and **modernize the core**



Modular, resilient technology with **cloud first** architecture



Proprietary in-house capabilities for accelerated design and go-to-market



Next gen **cyber security capabilities**

C

Build Future-ready Capabilities



Data architecture 3.0; moving beyond analytical models to **data engineering**



Integrating **alternate, unconventional data** for **risk-moderated growth**



Digital workforce for digital consumers



Creating a **cutting edge, future ready workspace 2.0**

Our digital strategy is aligned with our GPS strategy

A

Reimagine Customer Proposition



Digital-first products embedding design thinking



End-to-end simplification of customer journeys



Banking services **integrated across partner ecosystems**



Omnichannel experience to differentiate customer experience & hyper personalization

**B**

Transform the Core



Ops excellence & institutionalization of data & tech enabled operating rhythm



Twin-engine approach to build digital stack and modernize the core



Modular, resilient technology with cloud first architecture



Proprietary in-house capabilities for accelerated design and go-to-market



Next gen **cyber security capabilities**

C

Build Future-ready Capabilities



Data architecture 3.0; moving beyond analytical models to **data engineering**



Integrating **alternate, unconventional data** for **risk-moderated growth**



Digital workforce for digital consumers



Creating a **cutting edge, future ready workspace 2.0**

1: Best in class analytics solution leveraging alternate data to implement large scale models

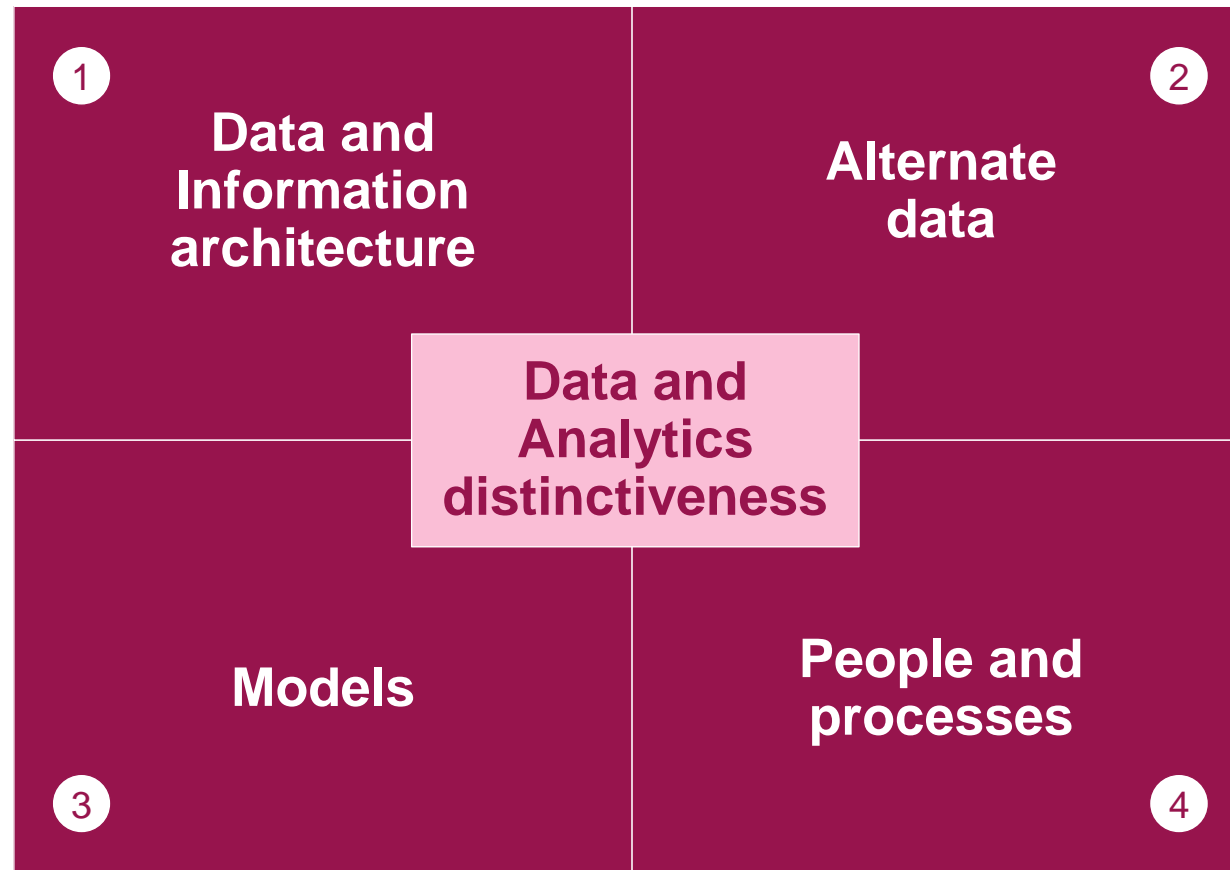

- 1 We have begun our **cloud data infrastructure** journey
- 2 We are building **alternate data platforms** to enable score-based underwriting for next 100 million+ customers
- 3 We are also implementing large number of **credit and marketing models** leveraging advanced techniques with new age data to drive better predictive and to drive sourcing
- 4 Agile team with expertise in **alternate data and risk set up**, and a robust test and learn approach to **risk framework and program building** and scale-up set up to drive the initiative

1: We are moving to Data Architecture 3.0

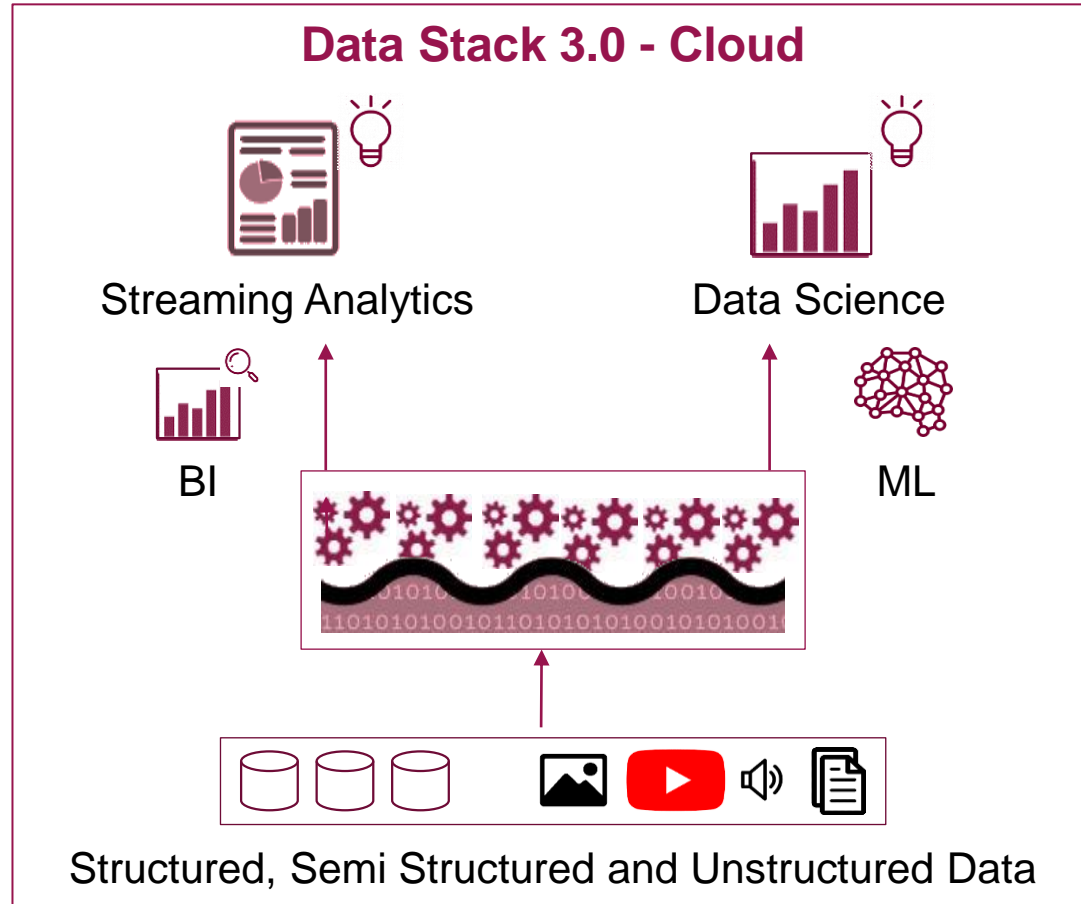

On the fly elasticity
Separation of compute from storage

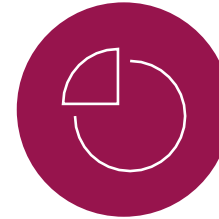

Big data clusters developed on Hadoop with PetaByte scale data



150+ use cases deployed across credit, fraud, marketing analytics on cloud decisioning platform

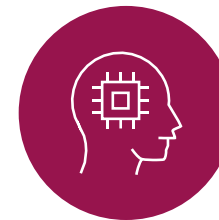

Multiple machine learning based credit models developed; 2000 attributes considered; up to 120% lift on GINI over generic bureau models

2: Integrating alternate unconventional data in Axis ecosystem for risk-moderated business expansion

We are starting to use **Information collateral** or data like **telecom score** and **farmland health metrics** for enabling underwriting capability for all Indians who walk through Axis doors, especially for new products or info-poor segments

Telecom Score

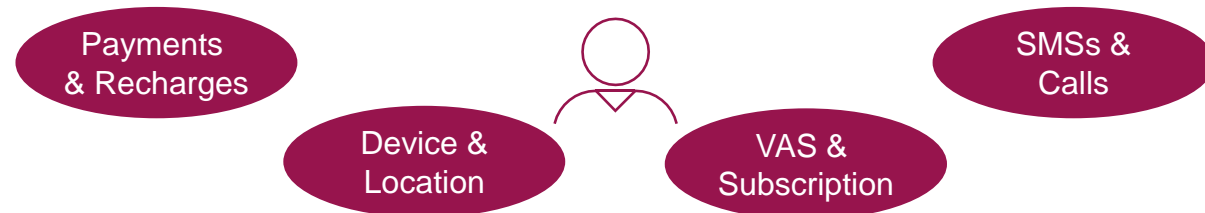

Access to **surrogate credit** score for crores of subscribers of one of the top telcos enabling Bank to offer gamut of products to huge fresh pool

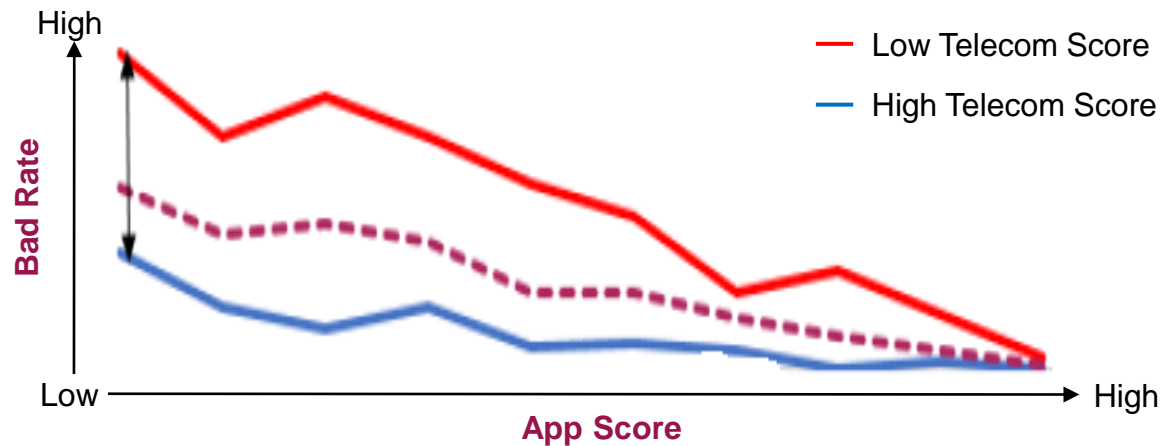

Validated on multiple products: Telecom score gives risk discrimination over and above underwriting scorecards

Farmland Health metrics



Crop Health Metrics generated from satellite images

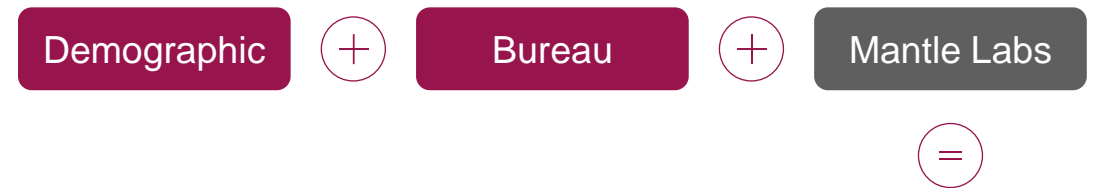

Inclusion in underwriting scorecard improves risk discriminatory power by **~10%**

2: Leveraging geo-location based income estimation models to enhance customer onboarding experience

Geo-Information based customer Lat-Long data used in KNN algorithm for 1st level estimates

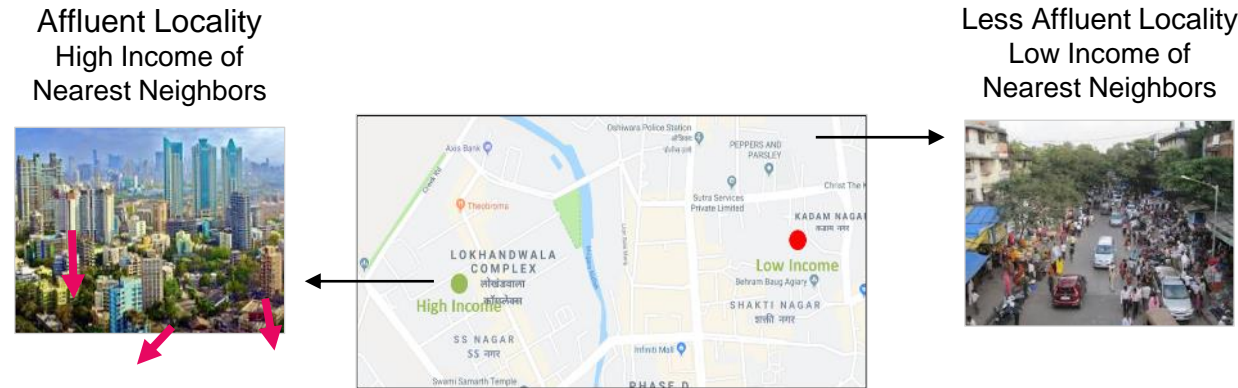

We are leveraging state-of-the-art cloud-infra for deploying the model in real-time

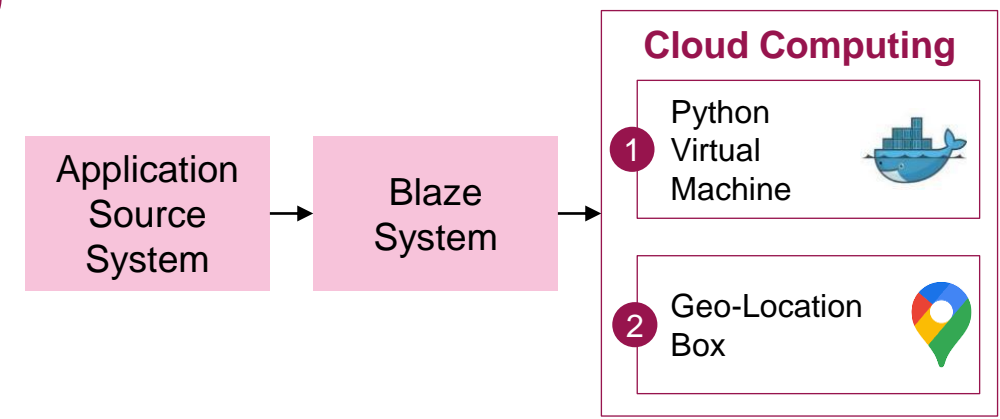

Neural network algorithm leveraged for obtaining the final estimates

Estimate Income using Bureau + Internal bank information + Output from 1

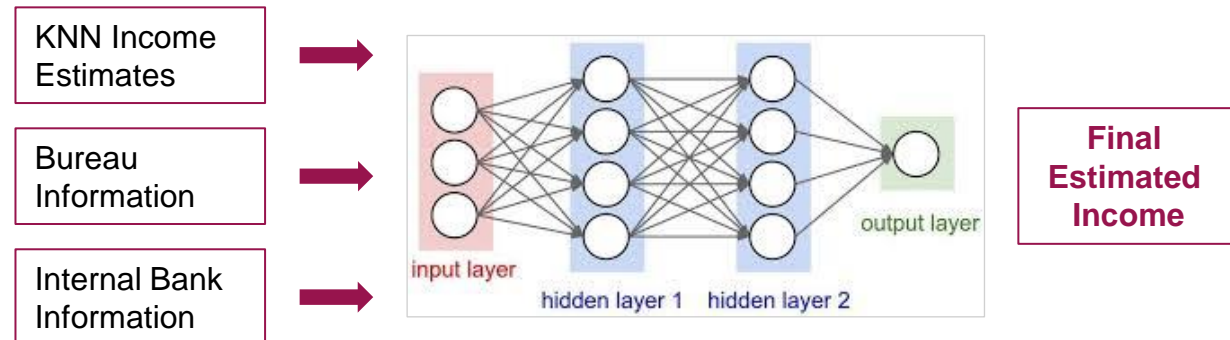

- 1 Python container box to help on-board non-linear algorithms to run in real-time on Blaze environment.
- 2 Real-time geo-location based K-Nearest neighbors to be leveraged for model-run.

3: KTB cards sourcing has started contributing significantly with good risk outcomes and activation rates

% of Business contribution

KTB (Known to Bank) base of **140 mn customers**

Built **market tested credit models** based on KTB data

Credit risk outcomes for KTB performing significantly better than expectations

Bank is currently launching **KTB based programs** – Focus is on scaling them going forward

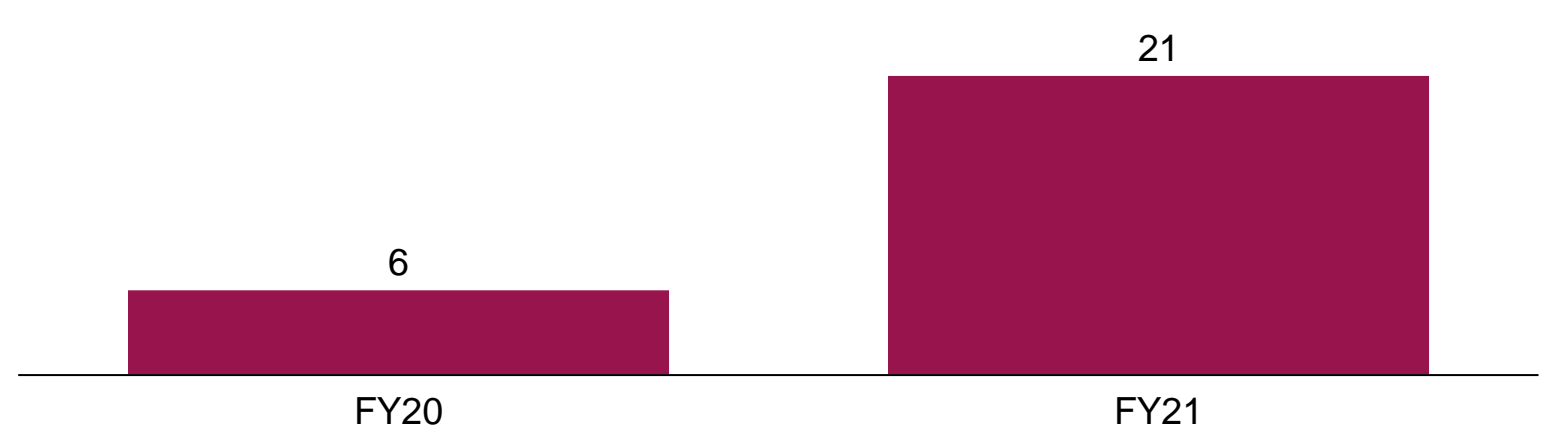

30 day activation rates (Indexed)

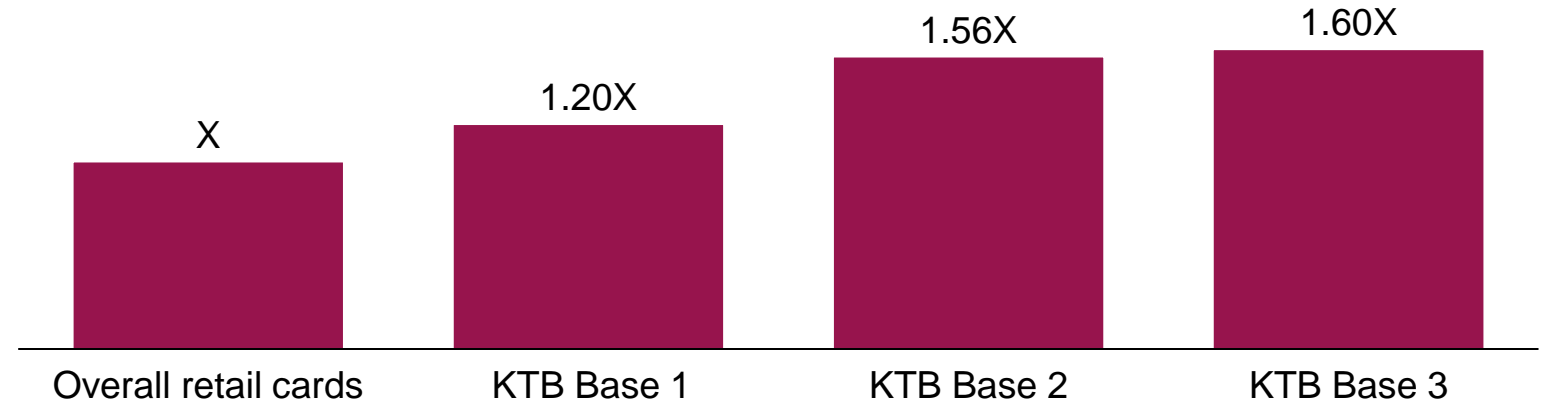

3: Large number of marketing models leveraging advanced techniques with new age data

Marketing models

Sourcing from DB programs (in Q1FY22)

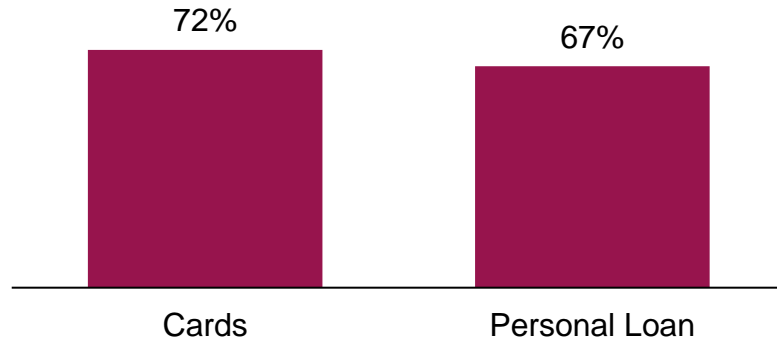

Propensity models for deposit business

Propensity Calendar contribution to portfolio

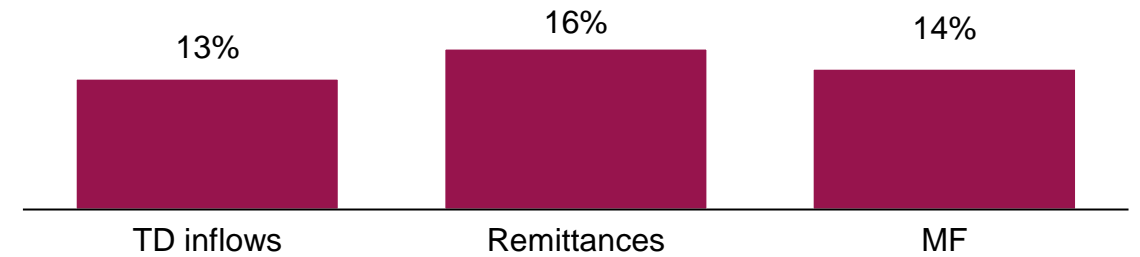

Our digital strategy is aligned with our GPS strategy

A

Reimagine Customer Proposition



Digital-first products embedding design thinking



End-to-end simplification of customer journeys



Banking services **integrated across partner ecosystems**



Omnichannel experience to **differentiate** customer experience & **hyper personalization**

**B**

Transform the Core



Ops excellence & institutionalization of data & tech enabled operating rhythm



Twin-engine approach to build digital stack and **modernize the core**



Modular, resilient technology with **cloud first** architecture



Proprietary in-house capabilities for accelerated design and go-to-market



Next gen **cyber security capabilities**

C

Build Future-ready Capabilities



Data architecture 3.0; moving beyond analytical models to **data engineering**



Integrating **alternate, unconventional data** for **risk-moderated growth**



Digital workforce for digital consumers



Creating a **cutting edge, future ready workspace 2.0**

Building the right team with the right talent



1000+

...people dedicated to digital agenda

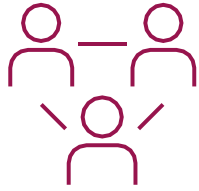

150

.. member strong in-house tech team

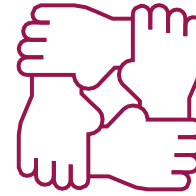

75% +

...new hires from non-banking background

- Fintech's
- E-commerce
- IT
- Consulting
- Campus
- Others

.. across roles forming full service teams

- Design
- Product managers
- Developers: Front-end, backend, full stack
- Dev-ops
- QA
- Scrum masters
- Digital marketers
- Partnerships
- Governance
- Channels

Our digital strategy is aligned with our GPS strategy

A

Reimagine Customer Proposition



Digital-first products embedding design thinking



End-to-end simplification of customer journeys



Banking services **integrated across partner ecosystems**



Differentiated customer experience leveraging **hyper personalization**

**B**

Transform the Core



Ops excellence & institutionalization of data & tech enabled operating rhythm



Twin-engine approach to build digital stack and **modernize the core**



Modular, resilient technology with **cloud first** architecture



Proprietary in-house capabilities for accelerated design and go-to-market



Next gen **cyber security capabilities**

C

Build Future-ready Capabilities



Data architecture 3.0; moving beyond analytical models to **data engineering**



Integrating **alternate, unconventional data** for **risk-moderated growth**



Digital workforce for digital consumers



Creating a **cutting edge, future ready workspace 2.0**

The organization is moving to more flexible ways of working...

Future of work 2.0



~15,000 Staff coverage under Hybrid Model

~2,250 Employees across 22 central departments moved to a 100% virtual format in two phases

130 Candidates hired in alternate formats under GIG-A Opportunities

Benefits

- Structural reduction in costs
- Better employee satisfaction
- Ability to attract new talent pools

... and creating a future-ready workspace

One Axis App

App with enhanced Self-Service and access to required information through ~30 modules

Onboarding

Virtual ID, visiting card & mandatory declarations for new joinees



Active Transaction

One screen view of benefits, employee profile, payroll and reimbursements, leave management, staff loans, ESOPs etc.

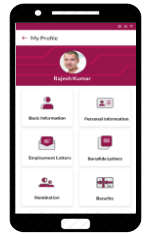

Others

COVID support – Online expert consultation, vaccination badge & reimbursement
Webcast, Axis Champions, My GPS, Contributions to social causes, Online Approval System, Tap P2P



Thank you

